

# IM-Modem 6

## Integration Manual for the Modem 6 Family

Type: 8307, 8244, 8182, 8193, 8377

---

Issue 03

Issue Date: 06 December 2023

## **Contents**

<b>Amendment history</b>	<b>5</b>
<b>Definitions</b>	<b>5</b>
<b>Related documents</b>	<b>6</b>
<b>1 Introduction</b>	<b>7</b>
<b>2 Who is this manual for?</b>	<b>7</b>
<b>3 Document conventions</b>	<b>7</b>
<b>4 Core concepts</b>	<b>7</b>
4.1 What is Modem 6?	7
4.2 Environmental considerations	8
4.3 What is Modem Data Frame Transfer (MDFT)	8
4.4 What modes are available?	8
4.4.1 Acknowledged mode overview	9
4.4.2 Fire and Forget mode overview	9
4.5 Interface ports	9
<b>5 User case scenarios</b>	<b>9</b>
5.1 Near Real Time remote data streaming	9
5.1.1 Acknowledged mode example	11
5.1.2 Fire and Forget mode example	14
5.1.3 Which mode is best for me?	16
5.2 Subsea sensor data harvesting	16
5.2.1 Data harvesting example	17
5.2.2 Which mode is best for me?	18
5.3 Vehicle data harvesting	18
5.4 Vehicle command and control	20
5.5 Acoustic command and control	22
<b>6 Hardware overview</b>	<b>23</b>
6.1 Single element vs Multi-element receivers	23
6.2 Serial communications	23
6.2.1 UART support	24
6.2.2 UART protocol	24
6.3 Cold start	25
6.4 Serial reset	25
<b>7 Modem 6 platform concepts and definitions</b>	<b>25</b>
7.1 Unit ID (UID)	25
7.2 Acoustic frequency band	25
7.3 Acoustic addresses	25
<b>8 Modem 6 protocol</b>	<b>26</b>
8.1 Acoustic modem challenges	26
8.2 MDFT	26
<b>9 Modem 6 configuration</b>	<b>27</b>
9.1 Reading fixed parameters	27

9.1.1	Unit ID	27
9.1.2	Firmware version	27
9.1.3	Transducer information	27
9.2	Basic acoustic configuration	27
9.2.1	Setting the acoustic gain	28
9.2.2	Setting the power levels	28
9.2.3	Setting the Receive Wait Time (RXW)	29
9.3	Modem specific parameters	29
9.3.1	Configuring the modem (MS command)	29
9.3.2	Transferring data (MDFT command)	35
9.4	Storing the configuration	36
<b>10</b>	<b>Example step-by-step integration</b>	<b>36</b>
10.1	Installation considerations:	37
10.2	Normal boot sequence	38
10.3	Initial configuration	39
10.4	Enabling diagnostics	39
10.4.1	Hardware self-test	40
10.4.2	Battery checks	40
<b>11</b>	<b>In depth integration examples</b>	<b>41</b>
11.1	Integration example 1 – Acoustic current profiler	41
11.1.1	Modem integration	41
11.1.2	Surface modem configuration	42
11.1.3	Subsea modem configuration	42
11.1.4	System operation	43
11.2	Integration example 2 – Water quality sensor (Transmissometer)	44
11.2.1	Modem integration	45
11.2.2	Surface modem configuration	45
11.2.3	Subsea modem configuration	45
11.3	System operation	46

## Figures

Figure 4-1	Modem scenario overview	8
Figure 5-1	Near Real Time data streaming	10
Figure 5-2	Data streaming: Acknowledged mode system diagram	12
Figure 5-3	MDFT frame data structure	13
Figure 5-4	Data streaming: Fire and Forget system diagram	15
Figure 5-5	Data harvesting	16
Figure 5-6	Data harvesting system diagram	17
Figure 5-7	UUV to subsea infrastructure interfacing	19
Figure 5-8	Vehicle data harvesting system diagram	20
Figure 5-9	UUV command & control	21
Figure 5-10	Winch basket command & control	21
Figure 5-11	Multi asset	22
Figure 8-1	Acoustic modem link challenges	26

Figure 10-1 Sound Velocity Profile	37
Figure 10-2 Ray path analysis	37
Figure 10-3 FFT Spontaneous noise floor increases	38
Figure 11-1 Integration example 1 system diagram	41
Figure 11-2 Integration example 2 system diagram	44

## **Tables**

Table 4-1 Interface port configuration	9
Table 5-1 MDFT maximum frame size vs telemetry scheme	13
Table 5-2 Data streaming: Acknowledged mode command sequence	14
Table 5-3 Data streaming: Fire and Forget mode command sequence	15
Table 5-4 Data harvesting command sequence	18
Table 6-1 Telemetry schemes	23
Table 6-2 Supported baud rates	24
Table 7-1 Address families	26
Table 9-1 Supported gain values	28
Table 9-2 Suggested RXW values	29
Table 9-3 MS command	30
Table 9-4 Data Delay	31
Table 9-5 Modem Delay	31
Table 9-6 Uplink Delay	32
Table 9-7 Telemetry Scheme	32
Table 9-8 Master Retries	33
Table 9-9 Missed Sub-frames	33
Table 10-1 Recommended configuration at varying slant ranges	39
Table 10-2 Volatile status command	40
Table 11-1 Integration example 1 pinout	42
Table 11-2 Integration example 2 pinout	45

## Amendment history

The amendment history records all amendments and additions made to this manual.

Issue	Date	Comments
A0	24/5/19	First issue
A1	29/7/19	Protocol Update
03	6/12/23	New branding

## Definitions

Abbreviation	Definition
ADCP	Acoustic Doppler Current Profiler
AUV	Autonomous Underwater Vehicle
BER	Bit Error Rate
CF	Configuration Flag
CRC	Cyclic Redundancy Check
CTD	Conductivity Temperature Density
DC	Data Count
DD	Data Delay
DP	Dynamic Positioning
FF	Fire and Forget
FFT	Fast Fourier Transform
FQ	Forward Queue
FS	Fixed Status
HDR	High Data Rate
ICT	Inter-Character Timeout
IEC	International Electrical Connector
LG	Linear Gain
LMF	Low-Medium Frequency
MD	Modem Delay
MDFT	Modem Data Frame Transfer
MF	Medium Frequency
MR	Master Retries
MST	Master
MU	Multi-user
MV	Modem Version
NPL	Navigation Power Level
QPSK	Quadrature Phase Shift Keying
RS	Reed-Solomon
RXW	Receive Wait Time

<b>Abbreviation</b>	<b>Definition</b>
SIU	Surface Interface Unit
SM	Sub-frames Missed
Sonardyne	Sonardyne International Limited and its affiliates
SPL	Start Power Level
SVP	Sound Velocity Profiler
THR	Threshold
TPL	Telemetry Power Level
TS	Telemetry Scheme
UART	Universal Asynchronous Receiver/Transmitter
UD	Uplink Delay
UID	Unit ID
UUV	Unmanned Underwater Vehicle

## **Related documents**

<b>Reference</b>	<b>Title</b>
<i>UM-8142</i>	<i>User Manual for Modem 6 Transceiver</i>
<i>UM-8190</i>	<i>User Manual for Modem 6 Mini &amp; Mini Dunker</i>
<i>UM-8300-Compatt 6</i>	<i>User Manual for Modem 6 Standard</i>
<i>UM-8309</i>	<i>User Manual for Modem 6 Dunker</i>
<i>UM-8370</i>	<i>User Manual for Modem 6 Sub-Mini</i>

## 1 Introduction

This manual provides the technical information required to integrate Modem 6 products to a vehicle/platform. Modem 6 shares a common acoustic and serial interface; this document is intended to sufficiently describe this shared interface to achieve a range of common operating scenarios.

## 2 Who is this manual for?

A Modem 6 can be used for a variety of applications. This manual covers the configuration and operation of the Modem 6 family. It aims to fulfil several common acoustic scenarios that the products are anticipated to perform.

## 3 Document conventions

The following conventions apply to this document:

- Where a number is prepended by "0x" it should be assumed that the following characters are a number in hexadecimal notation.
- Throughout the document syntax in **green** denotes commands sent to the modem and **blue** indicates responses from the modem.
- Where there are examples of command syntax shown within the document this will be shown in fixed width font and for clarity will not show the required **<CR>** and **<LF>** characters, i.e.

**<FS**

Should be interpreted as:

**<FS<CR><LF>**

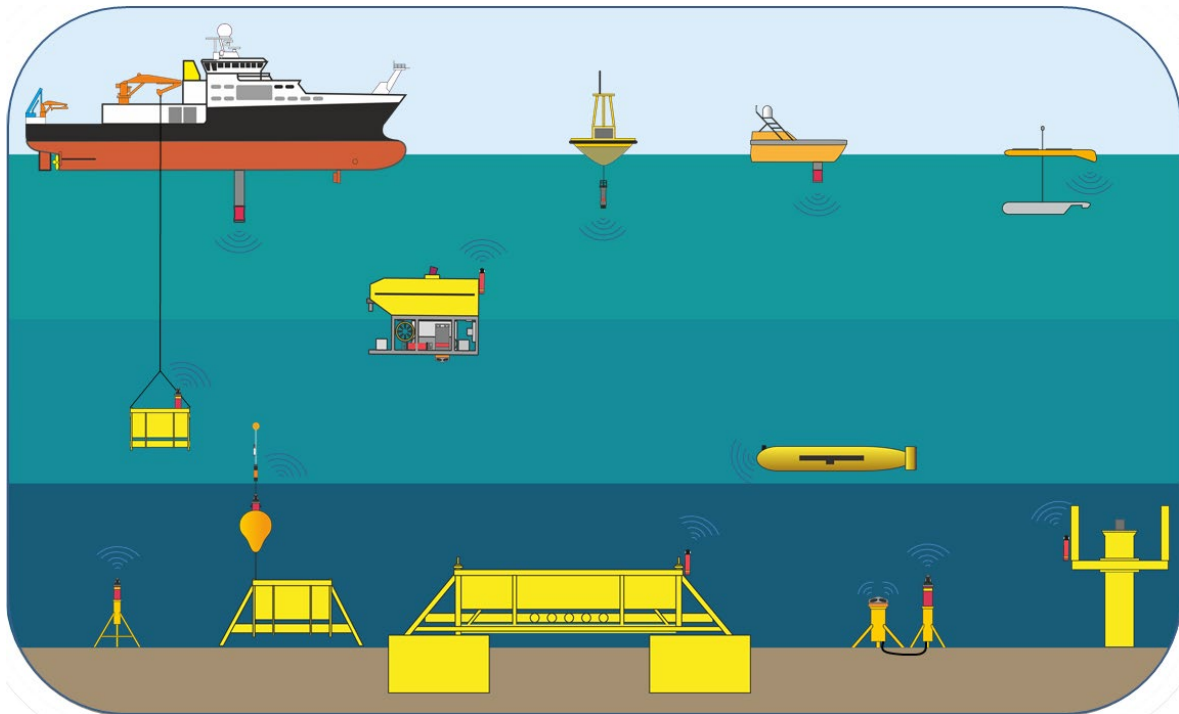
## 4 Core concepts

It is recommended that the reader is aware of these core concepts before reading the rest of the manual.

### 4.1 What is Modem 6?

Modem 6 is a part of the Sonardyne's 6G acoustic family. It is aimed at users who do not require the more complex functions of Sonardyne's core 6G range, such as: precise positioning, on-board sensors or complex multi-node array telemetry. As such it is ideally suited for simple applications that require a dedicated point to point data (address to address) transmission capability, while core 6G products, including OEM solutions, are available for more challenging applications. Modem 6 products can operate alongside other Sonardyne 6G products however they are limited to Modem operations.

Figure 4-1 Modem scenario overview



## 4.2 Environmental considerations

At the heart of Modem 6 is Sonardyne's Wideband<sup>®2</sup> signal processing, which provides unprecedented levels of robustness and flexibility in challenging acoustic environments. Advanced Quadrature Phase Shift Keying (QPSK) spread spectrum techniques and intelligent data packet stitching ensure that data throughput is maximised, latency is minimised and data is delivered error free. Consequently, depending on environmental conditions, Modem 6 supports actual acoustic data rates between 100 - 9,000 bps. To understand more about the environmental factors that affect the actual acoustic data rate; see *Section 8.1 "Acoustic modem challenges"*.

## 4.3 What is Modem Data Frame Transfer (MDFT)

MDFT is Sonardyne's overall acoustic protocol for transferring data, used in Modem 6 products. MDFT can refer to a single modem transaction that involves a pair of Modem 6 units, see *Section 8.2 "MDFT"* for further details.

## 4.4 What modes are available?

A Modem 6 has two modes of operation, "Acknowledged" and "Fire and Forget". Both modes use advanced Cyclic Redundancy Checks (CRC) to ensure the integrity of any data received by the user. CRC is an error detecting code which is commonplace in digital networks; raw data files are assigned check values when transmitted which can be used at the receiving end to check for corrupt or missing data. CRC also attempts to correct corrupt data, without needing to re-request it.

Both modes are suitable for different applications, so it is important to understand the benefits and limitations of each. To find out more about the typical user cases and recommended modes; see *Section 5 "User case scenarios"*.



#### 4.4.1 Acknowledged mode overview

The Acknowledged mode uses full two-way communications to ensure that all data sent through the acoustic link is received by the user. Any data lost due to environmental challenges will be re-requested automatically. This mode is excellent for ensuring all data is received, however it can compromise the speed of the link in challenging conditions.

#### 4.4.2 Fire and Forget mode overview

The Fire and Forget mode continuously streams any new data to minimise latency, for applications where losing the occasional piece of data is not critical. Any data that is missing will not be re-requested. This is ideal for relaying near real-time sensor data.

### 4.5 Interface ports

Most subsea modems and surface modems have two interface ports. These ports, which are labelled as Port 0 (P0) and Port 1 (P1) can both be configured as both a **command and control port** or a **binary data port**. Some modems only have a single port, for these units it is possible to pass both command and control along with binary data over the same port. This is achieved by setting the port to CF2. The Configuration Flag (CF) within the PORT command is used to set this:

**Table 4-1 Interface port configuration**

CF0	0 - Command port
CF1	1 - Modem data (raw binary)
CF2	2 - Auto detection - Port acts as a command port and attempts to auto-detect binary data

To set Port 0 as a data port and Port 1 as a binary data port the following command would be used:

```
PORT:P0;CF0,P1;CF1
```

## 5 User case scenarios

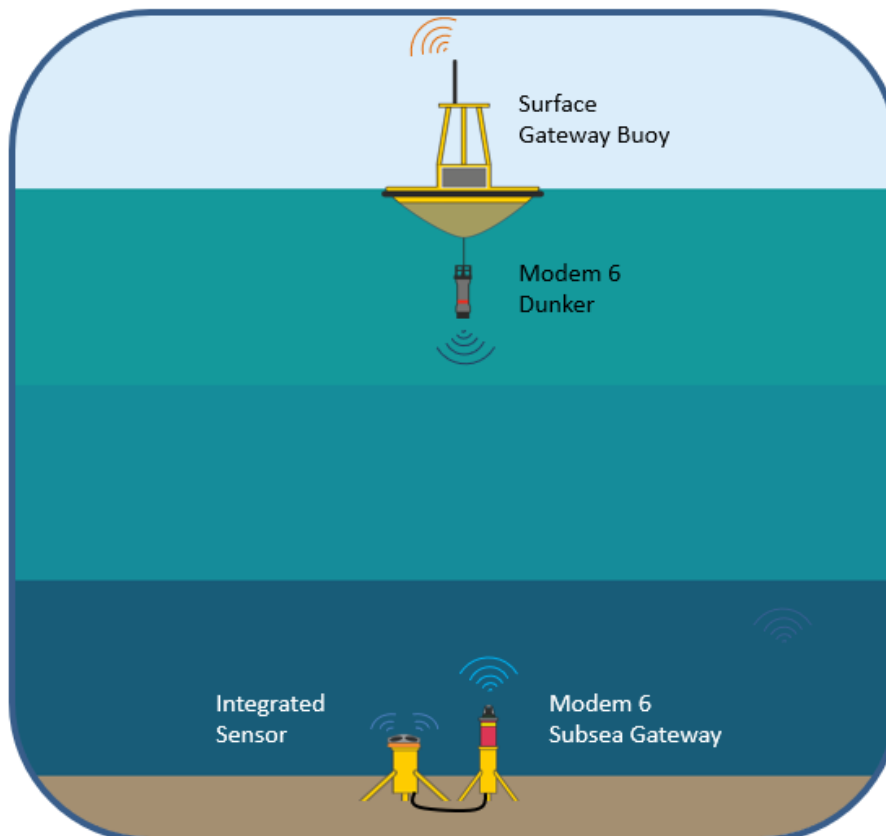
This section discusses common user case scenarios and evaluates the two Modem 6 modes based on the application's requirements. The specific application workflow and configuration is also explained.

### 5.1 Near Real Time remote data streaming

Acoustic modems are often used for streaming oceanographic data to the surface from a subsea sensor. A subsea sensor could be a: Acoustic Doppler Current Profiler (ADCP); Sound Velocity Profiler (SVP) or Conductivity Temperature Density (CTD). Mooring buoys offer a semi-permanent gateway for data uploads. Alternatively, an unmanned surface vehicle can be used with a compatible 6G directional Medium Frequency (MF) or Low-Medium Frequency (LMF) acoustic comms module (8290-002-01-A1 & 8290-002-03-A1 respectively).

In these situations, a Modem 6 Dunker or Modem 6 Mini-Dunker are the most suitable surface deployed Modems due to their size and power consumption. A Modem 6 standard may be a suitable choice for the subsea Modem because it offers the ability to power external sensors.

**Figure 5-1 Near Real Time data streaming**



In the example above, an ADCP is hard wired into the Modem 6 Subsea Gateway. The Modem 6 Subsea Gateway is able to provide an output power supply to the ADCP, to power the instrument. The ADCP would usually be preconfigured to output the required data stream at a specific data rate to the modem, when powered.

With data being received on the communication port of the Modem 6 Subsea Gateway, it can be dealt with in several different ways. Data is stored on the modems buffer until:

- Requested by the top side modem.
- The configurable modem buffer size limit is reached; it will then transmit this data to the surface modem; or
- A break in data received by the modem exceeds the modems Inter-Character Timeout (ICT).

---

**CAUTION**

**⚠ When the buffer size limit is reached any new data input into the modem will be discarded. The modem will resume acceptance of new data as space is made available within the buffer, as the backlog is cleared. Section 11.3 "System operation" explains how the user can manually reset the buffer, if required.**

---

Data can be transmitted in either an Acknowledged or Fire and Forget mode. The latter is most commonly used during data streaming where update rate is more important than re-requesting missed data. For this user case, an example of both modes is given in Section 5.1.1 "Acknowledged mode example" and Section 5.1.2 "Fire and Forget mode example" respectively.

---

### 5.1.1 Acknowledged mode example

In this example, the user has an ADCP connected to P1 of the Modem 6 Subsea Gateway, with the ADCP configured to output data at 1 Hz. Utilising the Acknowledged mode has several points worth noting, all data is automatically CRC checked via its handshake protocol and will re-request any lost/corrupted data. This means that there is a limit to the update rate as the system must first transmit its data and then wait for the acknowledgment. Subsequent ADCP messages sent to the modem will be stored until the previous transmit cycle is complete.

An additional benefit of this methodology is the ability to load the surface modem's MDFT buffer whilst data is being uploaded. For example, a sensor command to change the ADCP's update rate can be input into the surface modem. This command will then be automatically transmitted to the ADCP via the subsea modem as part of the surface modem's acknowledgment command.

Before any data transfer can begin, the user must configure the subsea modem by sending it the following MS command:

```
MS:2401,MV1,DD1024,MD4096,UD512,TS6,P1,MR1,SM1,THR1,ICT128,FQ1,MST1,MU0,FF0,B512/0.1
```

This command is sent into the command port of the surface modem (P0), this is then transmitted to the subsea modem, to update its configuration. The command will be echoed back from the subsea modem if the update is successful.

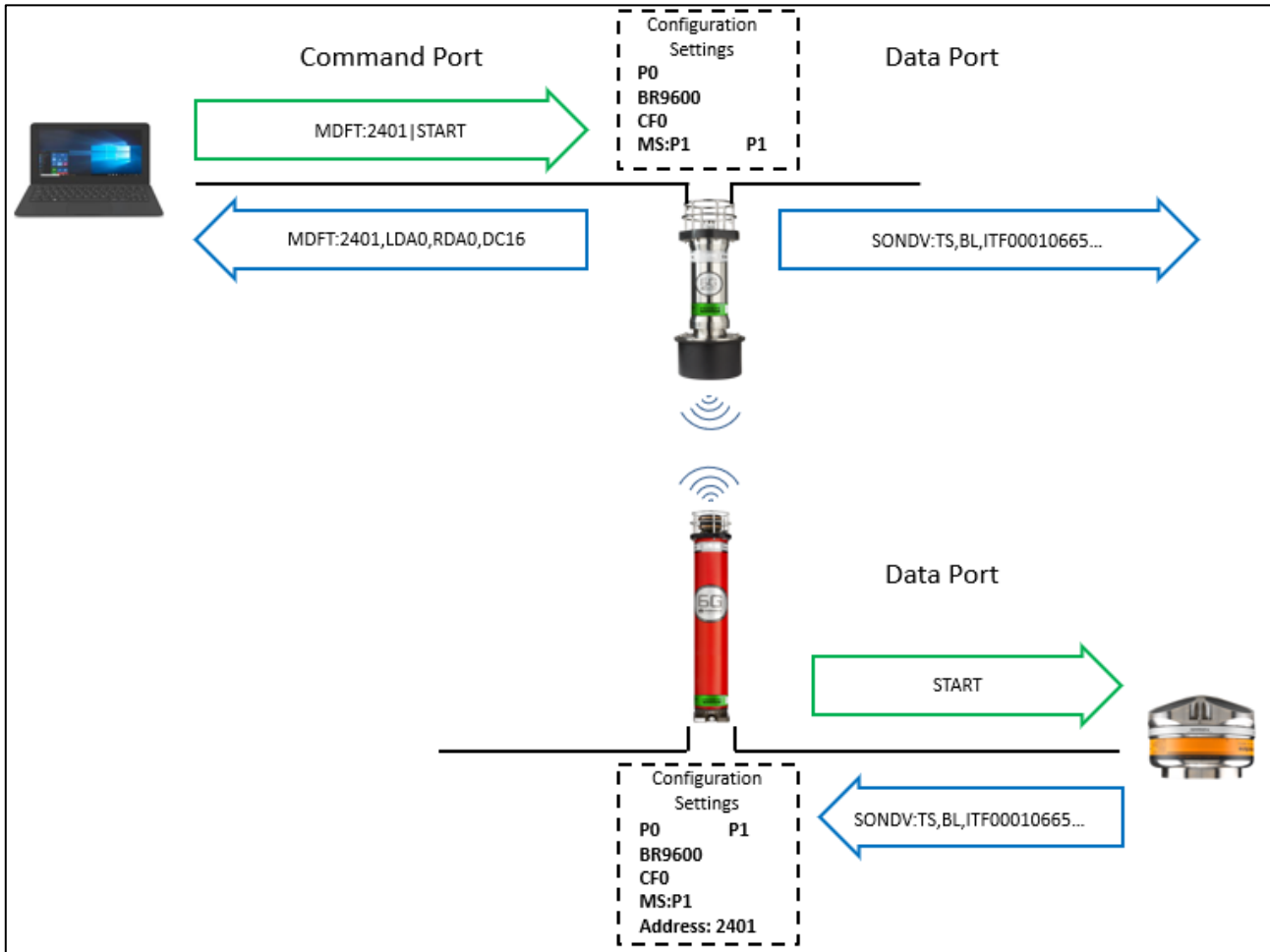
The subsea modem will be set to its Master (**MST**) configuration; this means that once an MDFT connection is established with the surface modem the subsea modem will automatically transmit the data within its buffer.

With the ADCP powered and in standby the Surface Gateway Buoy can now command the ADCP to start by sending the appropriate command to the Modem 6 Subsea Gateway. In this example it is assumed that the ADCP is preconfigured and awaiting a "**START**" command to begin outputting data:

```
MDFT:2401,RS3|START
```

The Modem 6 Subsea Gateway will then output the "START" message to the ADCP which in turn will stream its data strings to the modem. Upon receiving a data string, the modem will wait for the ICT value after the last character is received before transmitting the data to the surface modem. Upon receipt of the data the surface modem will perform a CRC check on the data. If all CRC corrections pass then the unit will acknowledge this to the subsea modem allowing it to transmit the next payload. If there are uncorrectable errors the surface modem will re-request that data.

Figure 5-2 Data streaming: Acknowledged mode system diagram



### 5.1.1.1 Acknowledged mode (frames & telemetry schemes)

Data in the modem's buffer that is awaiting transfer is broken into frames, each of which is broken down into a maximum of 16 sub-frames. These sub-frames are further broken down into up to 16 blocks of data. The amount of data contained within each frame is defined by the telemetry scheme that the modem has been configured to, as seen in *Figure 5-3* and *Table 5-1*.

Figure 5-3 MDFT frame data structure

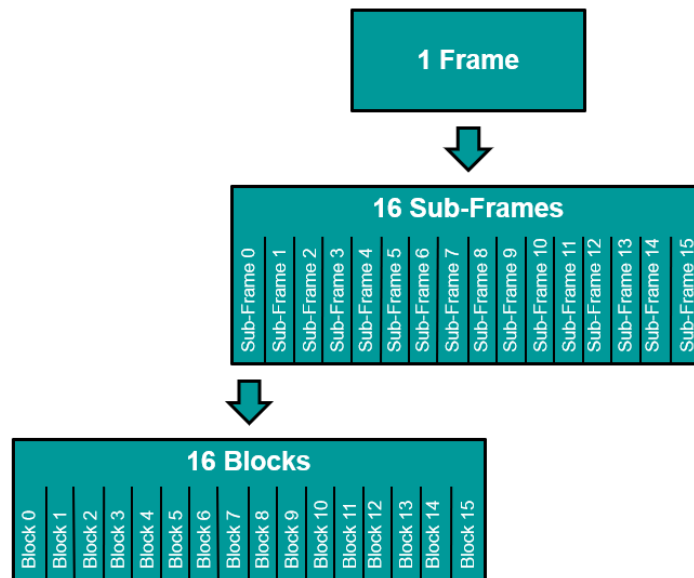


Table 5-1 MDFT maximum frame size vs telemetry scheme

Scheme	Maximum MDFT frame size
TS0 (100 bits/s)	608 bytes
TS1 (200 bits/s)	1,376 bytes
TS2 (400 bits/s)	2,656 bytes
TS3 (900 bits/s)	5,728 bytes
TS4 (3000 bits/s)	27,488 bytes
TS5 (6000 bits/s)	55,136 bytes
TS6 (3500 bits/s)	30,048 bytes
TS7 (9000 bits/s)	83,808 bytes

Upon receipt of the transmission, each block of data is CRC checked, and corrected where possible. The data is then re-assembled into a whole frame to be outputted via the modem’s serial port. If any of the sub-frames fail CRC re-assembly, the modem will automatically re-request this data a defined number of times, until it is re-assembled. The number of times that the modem will retry the data upload is dictated by the Master Retries (MR) value, within the MS settings of the modem; by default, this is set to two retries.


**Table 5-2 Data streaming: Acknowledged mode command sequence**

	Surface modem	Subsea modem
Command input into surface modem's command port (P0) to clear subsea modem's buffer and send "START"	MDFT:2401,RS3 START	
Data output from subsea modem's data port (P1), to the ADCP		START
ADCP streams data back to subsea modem on (P1)		>SONDV:TS;BL,ITF00010665.515351,...
Surface modem receives data but sub-frame 7 is incomplete and re-requested		
Subsea modem re-transmits sub-frame 7		
Surface modem re-assembles the complete data set		
Data output from surface modem		>SONDV:TS;BL,ITF00010665.515351,...
		>SONDV:TS;BL,ITF00010666.515351,...
User loads "STOP" on surface modem to be sent along with the next data received acknowledgement	MDFT: STOP	
Subsea modem outputs "STOP" to ADCP		STOP

### 5.1.2 Fire and Forget mode example

In this example the same system setup is utilised but instead of using the acknowledgement functionality (*Section 5.1.1 "Acknowledged mode example"*), the Fire and Forget mode is enabled. The advantage of this mode is that it enables data to be streamed with much lower latency for applications where it is more important to have live data, where packet loss is acceptable.

#### CAUTION

 **If the sensor is streaming data to the subsea modem at a high rate, for example 1 Hz, it may not be possible to send a command acoustically from the surface modem to the subsea modem. This is because the link is half duplex and there may not be enough time in between the subsea modem's data packets.**

**If this is the case, a stop command cannot be sent to the ADCP, to halt its data output. In this case the modem will continue to transmit indefinitely. For this application it would be advisable to use the ADCP as a master and command it to only output data for a defined period of time.**

As in the previous example, the subsea modem's MS configuration must be set. The Threshold (**THR**) flag and the Master (**MST**) flag will be set followed by the Fire and Forget (**FF**) flag:

MS:2401,MV1,DD1024,MD4096,UD512,TS6,P1,MR1,SM1,THR1,ICT256,FQ0,MST1,MU0,FF1,B512

Figure 5-4 Data streaming: Fire and Forget system diagram

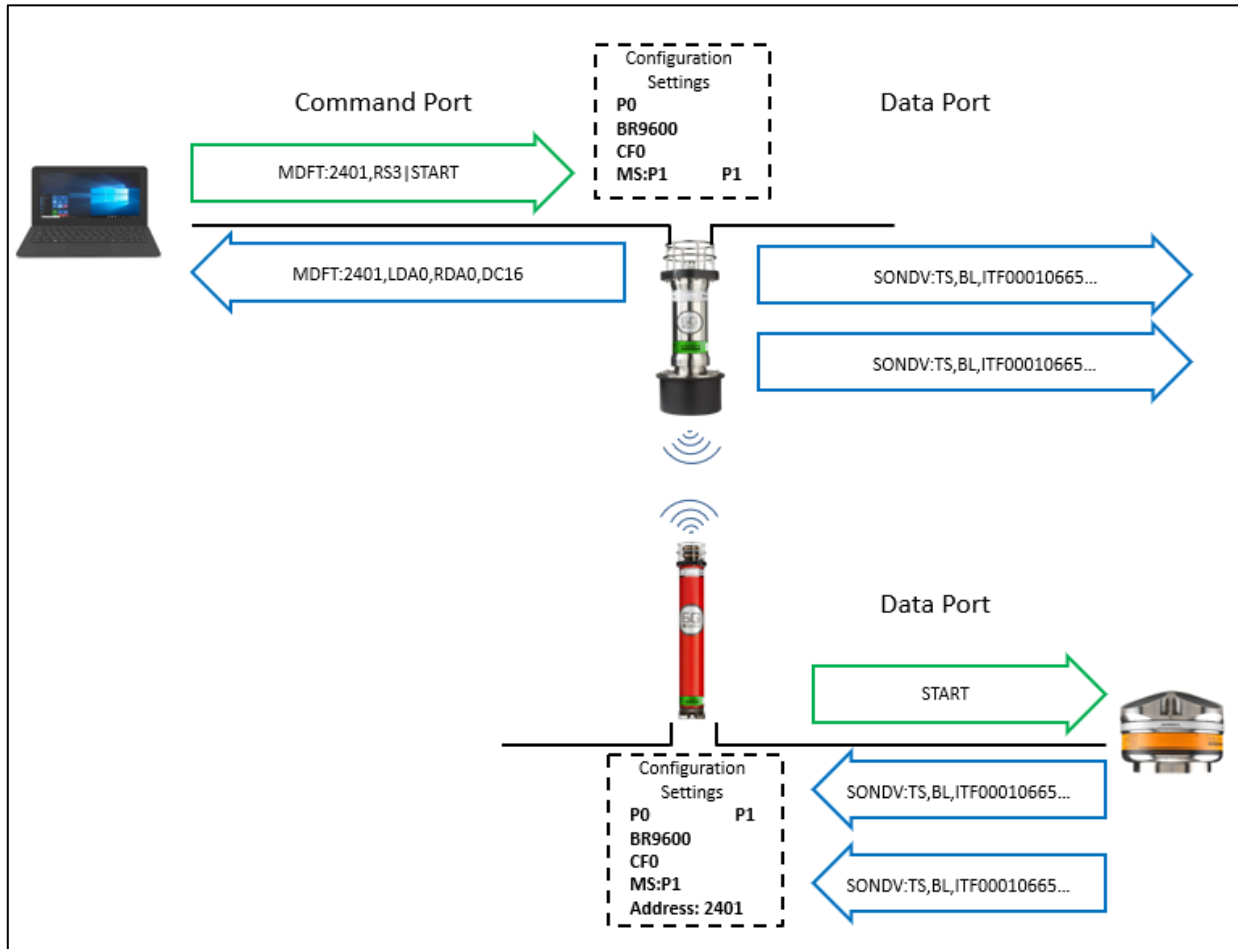


Table 5-3 Data streaming: Fire and Forget mode command sequence

	Surface modem	Subsea modem
Command input into surface modem's command port (P0) to clear subsea modem's buffer and send "START"	MDFT:2401,RS3 START	
Data output from subsea modem's data port (P1), to the ADCP		START
ADCP streams data to subsea modem		>SONDV:TS;BL,ITF00010665.515351,...
Data outputted from Surface modem	>SONDV:TS;BL,ITF00010665.515351,...	
ADCP streams data to subsea modem		>SONDV:TS;BL,ITF00010665.515351,...
Data output from Surface modem	>SONDV:TS;BL,ITF00010666.515351,...	

### 5.1.3 Which mode is best for me?

Both methods of use described above are suitable in different situations, each with their own advantages and limitations.

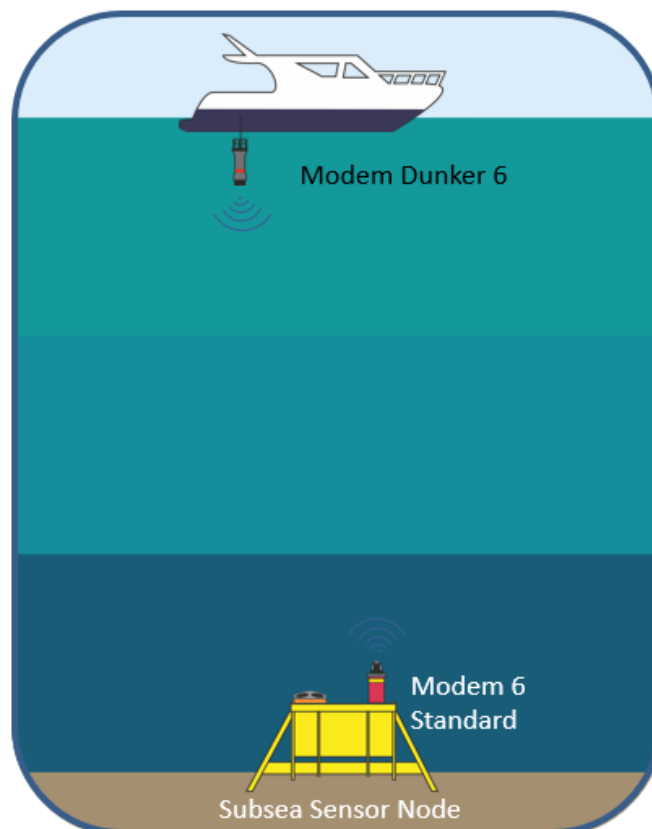
The Acknowledged mode of operation is suited for users who are interested in receiving the data without any losses. It should also be used when a slower update rate is expected, this suits the two-way data acknowledgment.

Fire and Forget is ideal when a fast update rate is the main consideration and when the user can accept some data loss. It should be remembered that if the user has a very fast update rate it can be difficult to schedule acoustic commands down to the subsea modem to disable the attached sensor. Sonardyne advises that the user should ensure that the sensor will only be active for a set period, once started.

## 5.2 Subsea sensor data harvesting

Long term subsea sensor nodes are used for sustained data collection from many different sensors, including ADCP, SV, and CTD. Historically it was necessary to release these stations (nodes) from their moorings in order to recover data. An acoustic modem enables data to be recovered whilst leaving the unit to remain operating in situ.

Figure 5-5 Data harvesting



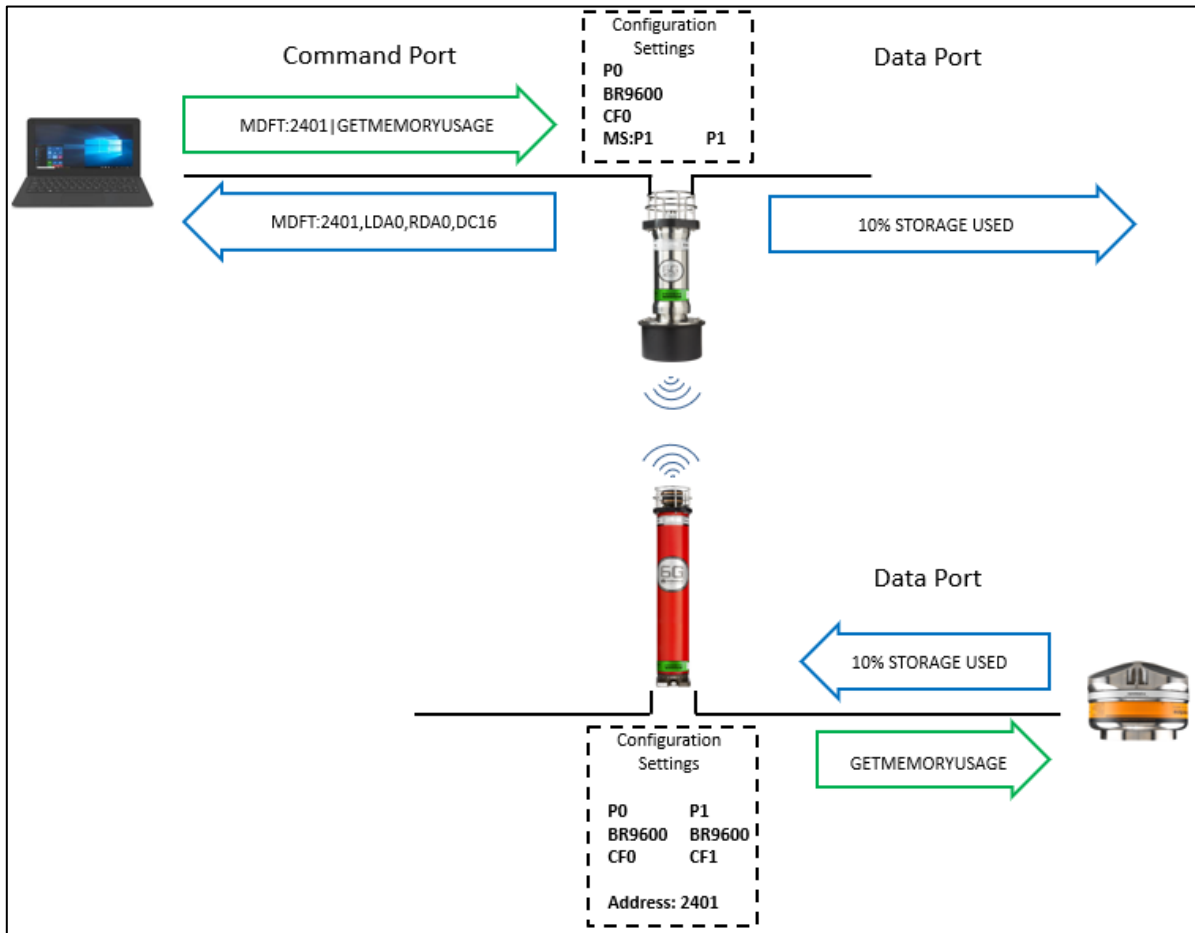
Data harvesting can be carried out by using any vessel of opportunity, from a small fishing vessel to a large survey vessel. An autonomous over- the-horizon vehicle could also be used.



### 5.2.1 Data harvesting example

In this example, the Modem 6 Standard is connected on its P1 port to a data logger. The Modem 6 Standard must be configured for how the user wants both the received acoustic data and the serial data to be handled:

Figure 5-6 Data harvesting system diagram



The following command is used to configure port P1 to a baud rate of 9600 as well as setting it as a data port, rather than a command port:

```
PORT:2401;W1,P0;BR9600;CF0,P1;BR9600;CF1
```

As shown in Figure 5-6, the user does not have physical access to the subsea modem’s command port, so the command must be sent via the surface modem. This is done by sending the above command into the surface modem’s command port P0.

**Note**

**If the user has physical access to the subsea modem’s command port, the same command would only work without the address (2401). PORT:P0;BR9600;CF0,P1;BR9600;CF1.**

The subsea modem must then be told which physical port to route modem communications between, this uses the MS command:

```
MS:2401;W1,MV1,DD1024,MD1024,UD512,TS6,P1,MR1,SM1,THR1,ICT256,FQ0,MST0,MU0,FF0,B512
```

The above sets the modem to the required configuration for the subsea data logger, details of the individual parameters can be found in Section 9.3 "Modem specific parameters".

The user must also configure the MS settings of the vessel’s modem, to ensure the data is outputted on the correct port:

`MS: MV1, DD1024, MD512, UD512, TS1, P1, MR1, SM1, THR0, ICT256, FQ0, MST0, MU0, FF0, B512`

The user is now able to utilise the MDFT protocol command to transfer the data between the modems.

The top side sends the acoustic interrogation to the Modem 6 Standard which is configured to the acoustic address 2401 with the message payload **GETMEMORYUSAGE**

`MDFT: 2401 | GETMEMORYUSAGE`

When received by the subsea beacon this will be passed out of the predefined data port as:

`GETMEMORYUSAGE`

Once this has been outputted from the subsea modem, it will wait for the configured Modem Delay (MD) before replying. In the example above the MD is set to 1024, so the unit will wait 1024 ms before acknowledging the command. If no data is fed into the subsea modem within the 1024 ms then the resulting output from the surface modem will be as follows indicating that the Data Count (DC) is 0:

`MDFT: 2401, LDA0, RDA0, DC0`

If the modem had received a reply within the 1024 ms then that data will be transmitted to the surface modem. Firstly an acknowledgment to the MDFT is sent to the serial port used to interrogate the modem, followed by the data packet being output on the port configured within the MS command. For example, if the MS is set to P0 and the command is sent from P0, then the reply will be similar to the following:

`MDFT: 2401, LDA0, RDA0, DC16 | 10% STORAGE USED`

**Table 5-4 Data harvesting command sequence**

	Surface modem	Subsea modem
Command sent to surface modem	<code>MDFT: 2401   GETMEMORYUSAGE</code>	
Data output from subsea modem		<code>GETMEMORYUSAGE</code>
Customer datalogger reply to subsea modem		<code>MDFT:   10% STORAGE USED</code>
Data output from surface modem	<code>MDFT: 2401, LDA0, RDA0, DC16   10% STORAGE USED</code>	

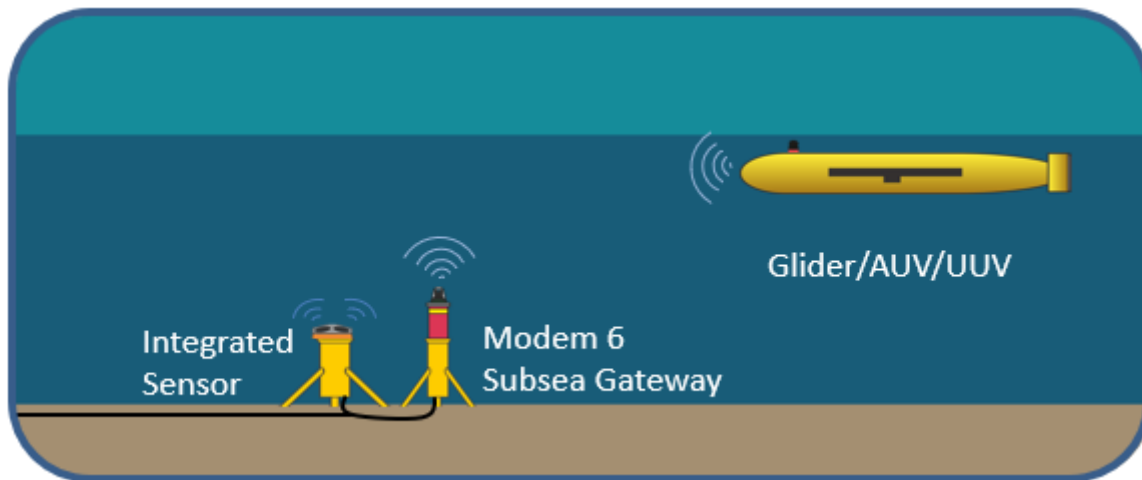
### 5.2.2 Which mode is best for me?

When uploading data from a storage device it is usually required that all of the data on the storage device is recovered with no missing data. Acknowledged mode would be used to do this. As in the previous examples, this method guarantees that the data delivered to the top side modem is uncorrupted and all present. This is essential when attempting to look at long term patterns in data from your subsea systems.

## 5.3 Vehicle data harvesting

As part of resident Autonomous Underwater Vehicle (AUV), unmanned underwater vehicles (UUV), or remote operations, it is possible to use both the AUV to interface and upload data from subsea infrastructure or the reverse and interface to the AUV from a cabled subsea base station.

Figure 5-7 UUV to subsea infrastructure interfacing



In previous examples both the Acknowledged and Fire and Forget modes have been used in a Master to Slave configuration.

The Master configuration has several different options. If the Master configuration is selected, the modem will automatically transfer data to the matched modem based on one of the following options:

- ICT – Using this setting the modem will not transmit data until the ICT value (in ms) has expired between serial input.
- THR – Sets the number of sub frames of data which must be filled before the modem will transmit its payload. The amount of data contained within each sub-frame is dependent on the telemetry scheme as described in *Section 5.1.1 "Acknowledged mode example"*.

In this example the Modem 6 is integrated onto an AUV that will be streaming data back to shore, via a cabled Modem 6 Subsea Gateway. The AUV is selected as a Master and the end user requires the data to be sent back once the payload is a set size.

After initial testing the user has decided to utilise Telemetry Scheme 7 for the data transfer, see *Section 9.3.1.1 "MV: Modem Version"* for further details. Telemetry Scheme 7 operates at 9000 bits/s and has a maximum size of 83,808 bytes, with each sub-frame holding 5,238 bytes. The user has also selected to buffer 2 sub-frames at a time.

Firstly the Modem 6 Subsea Gateway is configured; the Port of this unit must be configured to work with binary data and to also output that data over the secondary comms port, P1. The following command is used to achieve this:

```
PORT:2401;P0;BR9600;CF0,P1;BR9600;CF1
```

The MS settings for the subsea modem should then be configured for the correct port, Threshold (**THR**) and Master (**MST**).

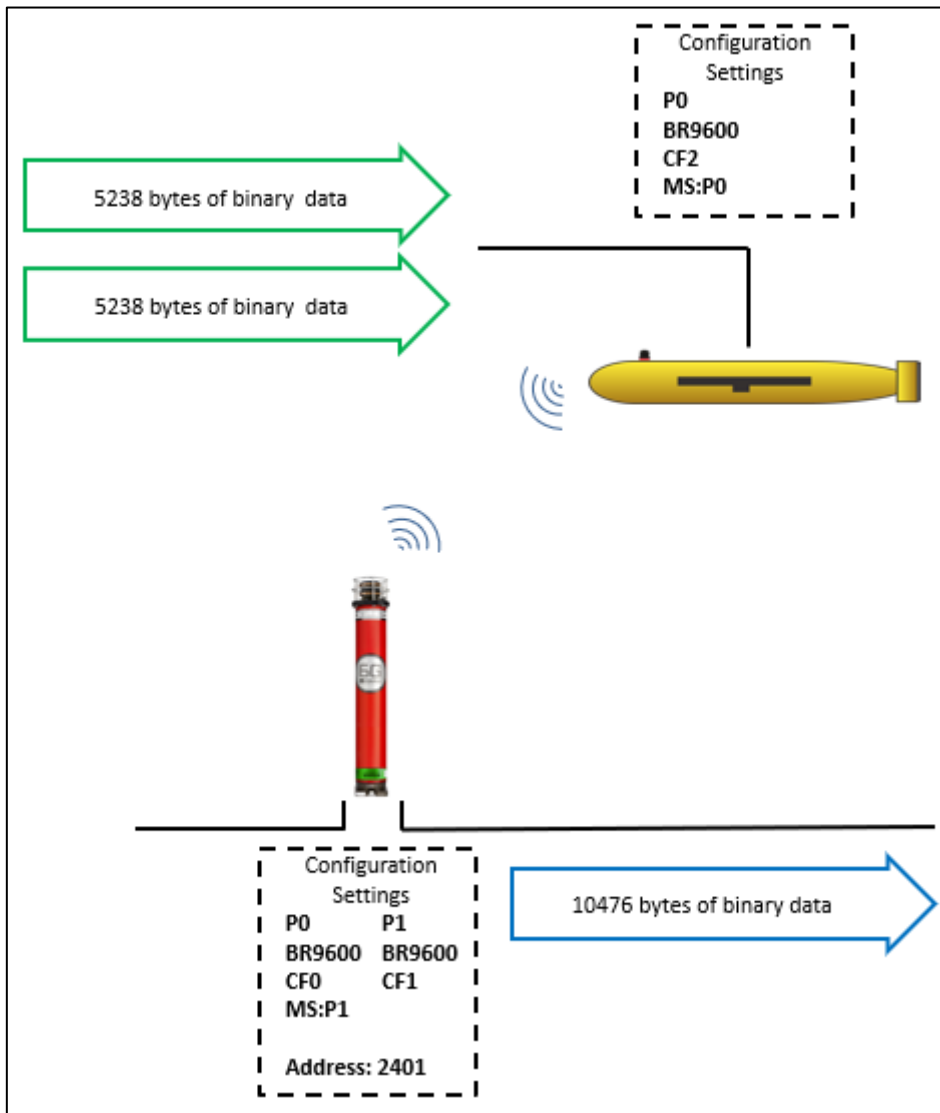
```
MS:2401,MV1,DD1024,MD4096,UD512,TS6,P1,MR1,SM1,THR0,ICT124,FQ0,MST0,MU0,FF0,B512
```

With the subsea gateway modem ready to accept data, the AUV can be configured. A setting not previously used, is the autodetect port. This offers the ability to automatically detect if the incoming data is binary data or a Modem 6 command. Meaning that the user can send both commands and binary data on the same port. This is done by using the Port command to set **CF2**:

```
PORT:P0;BR9600;CF0,P1;BR9600;CF2
```

```
MS:MV1,DD1024,MD4096,UD512,TS6,P1,MR1,SM1,THR2,ICT124,FQ0,MST1,MU0,FF0,B512
```

**Figure 5-8 Vehicle data harvesting system diagram**



## 5.4 Vehicle command and control

With UUVs becoming more common and more capable, the ability to interact with them during a mission is becoming more significant. The purpose for these communications may include: updating the UUV's real world position, checking the vehicles health status, transmitting new mission objectives, offloading sensor data or simply aborting the current mission.

Figure 5-9 UUV command & control

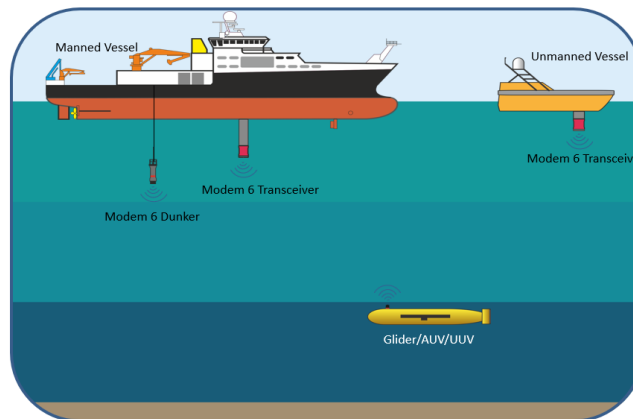
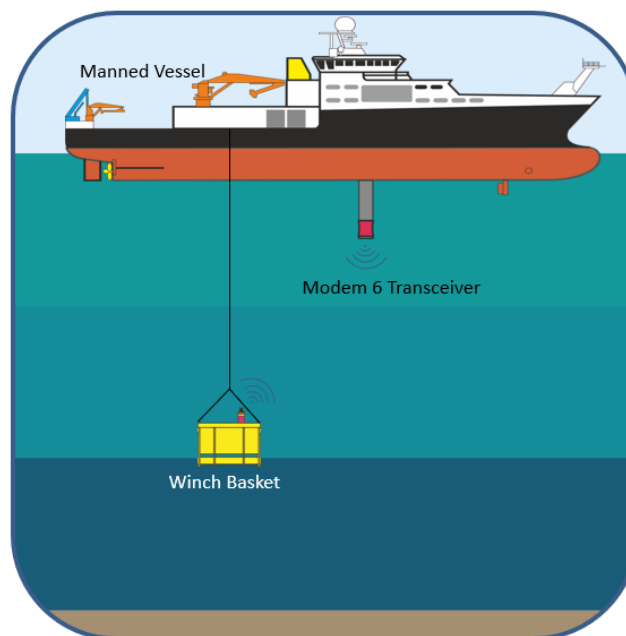


Figure 5-10 Winch basket command & control



When using a Modem 6 for AUV/Instrument command and control purposes there are two modes of operation:

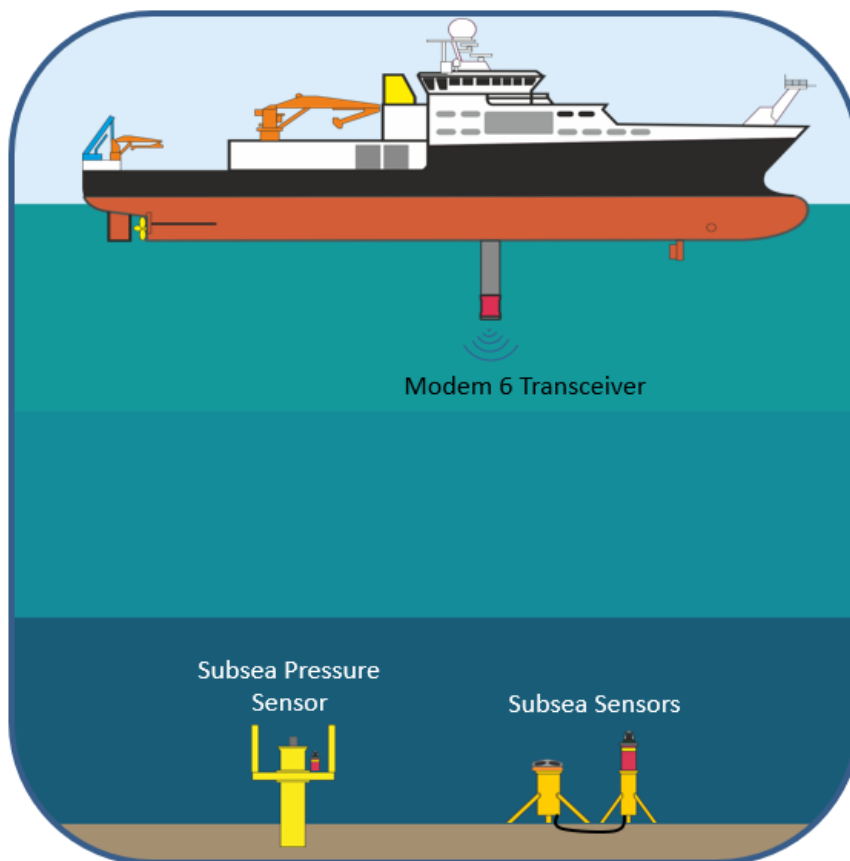
- For command and control scenarios the Acknowledged mode is recommended. The data retries will automatically carry out CRC correction on each of the individual data packets, any data which cannot be corrected will be re-requested from the glider modem. This is ideal for sending updated mission plans or changing the configuration/settings on the unit as the user will know that the information has successfully been received by the remote unit.
- Fire and Forget mode can be useful for passing data such as positioning updates down to the remote unit. This enables the remote vehicle logs to append position into their data sets. The data being sent down during this process may not be deemed mission critical and so the Fire and Forget mode would be most suitable. A faster update rate can be achieved.

A second application of these methodologies could be to control an instrument on a winch basket such as a CTD; the Modem could be used to control the acquisition of water samples or provide live data feeds from sensor packs.

## 5.5 Acoustic command and control

In a large set of subsea infrastructures, there may be an array of different hardware connected via independent modems. Modem addressing allows a single surface modem to interface with multiple subsea devices one at a time, by using software to interface to a command and response architecture.

Figure 5-11 Multi asset



In this example a user may have sensors outputting data that they wish to stream, alongside fixed infrastructure with logged data to be retrieved. Modem 6 operations are point-to-point so 3<sup>rd</sup> party user-sourced software would be required to interface with the surface modem to automate the switching between the two subsea modems. Alternatively, this could be done manually but would be time consuming.

## 6 Hardware overview

This section provides a non-exhaustive description of the available Modem 6 products.

### 6.1 Single element vs Multi-element receivers

The Sonardyne Modem 6 range has two variants of surface modems; Single element as found on the Modem 6 Mini-Dunker and the Modem 6 Dunker and Multi-element as found in the Modem transceiver. Although both appear to operate in the same way, they operate differently (internally) with each type having different advantages and disadvantages.

Modem 6 transceivers (type 8182 and 8193) are high performance dunker systems containing multiple receiver elements. These elements provide spatial diversity which gives improved performance in noisy and reverberant environments for all telemetry schemes. In addition, the performant hardware allows more advanced signal processing decoding techniques which the 3,000 bps and 6,000 bps telemetry schemes have been designed to exploit. The Modem 6 transceivers however do consume more power than the single element versions and contain no battery, meaning they must always be externally powered.

In addition to the differences above, between single and multi-element modems, there are also two telemetry schemes, only compatible with multi-element receivers. Any modem can transmit TS4 and TS5 but only a multi-element receiver is capable of decoding the data.

The following is a list of the telemetry schemes, their Actual Acoustic Data Rate and the supported modems:

**Table 6-1 Telemetry schemes**

Telemetry scheme parameter	Actual Acoustic Data Rate and telemetry type	Supported modem
0	100 bps	All modems
1	200 bps (default)	All modems
2	400 bps	All modems
3	900 bps	All modems
4	HDR 3000 bps	Multi-element receivers only
5	HDR 6000 bps	Multi-element receivers only
6	3500 bps	All modems
7	9000 bps	All modems

#### Note

 The available telemetry schemes depend on firmware version and hardware platform capabilities. Attempts to select a telemetry scheme that is unavailable will be ignored by the instrument.

### 6.2 Serial communications

As described previously, the serial ports of the modems are fully configurable. All units can be configured to the preferred board rate, see *Section 6.2.1 "UART support"*. Some units can also switch between RS232 and RS485; see *Section 6.2.2 "UART protocol"*.

### 6.2.1 UART support

Each Modem 6 supports at least one Universal Asynchronous Receiver/Transmitter (UART). The UART uses standard RS232 signalling protocol and supports the following baud rates.

Table 6-2 Supported baud rates

Supported baud rates
2400
4800
9600
19200
38400
57600
115200

#### Note

 **Hardware or software flow control is not supported as standard.**

To set port 0 of a modem to a baud rate of 57600 the user would send the command:

```
PORT:P0;BR57600
```

#### Notes

 **Some Modem 6 products have two UARTs, this allows one to be dedicated to command and diagnostic monitoring.**

 **Although the UART(s) have configurable baud rate they are fixed to 8 data bits, 1 stop bit and no parity (8N1).**

 **Some modems such as the Modem 6 Dunker and Modem 6 Transceiver can switch between RS232 and RS485 Half Duplex.**

### 6.2.2 UART protocol

Depending on the unit in use, some have the ability to operate on either RS232 or RS485 half-Duplex. To change between these on port 0 the user would send one of the following commands:

```
PORT:P0;RS232
```

```
PORT:P0;RS485
```

As with all Modem 6 command language, the user is able to set all or parts of a configuration with a single command rather than having to set each parameter with a separate command. For example, the following command would set port 0 to a baud rate of 57600 on RS232 and configure the port as a command port whilst simultaneously setting port 1 with a baud rate of 115200, RS485 and as a binary data port:

```
PORT:P0;BR57600;RS232;CF0,P1;BR115200;RS485;CF1
```



## 6.3 Cold start

On a cold start, for example, on first connection of a battery or on the receipt of a comms break, the configuration for the Modem 6 unit is loaded from non-volatile memory. In addition, a PORT command response is outputted (at 9600 baud) to any serial port that is configured as a command port.

An example of a PORT response is as follows:

```
>PORT:2010,P0;BR38400;CF0;RS232,P1;BR38400;CF1;RS232
```

---

### Note

 **The PORT response sent on a cold start is always serially transmitted at 9600 baud regardless of the configured baud rate of the serial port. This allows a method of determining the baud rate (for command ports) when it is unknown.**

---

## 6.4 Serial reset

A full reset can be triggered by an external host system by either sending a serial break to a serial port or by sending UNLK<CR> at 9600 baud. Both reset mechanisms are detected and actioned by a processor independent to the main acoustic / serial processor. The response to either of these will be a PORT reply at 9600 baud.

---

### Note

 **It is recommended that the serial receive line is asserted for a period of at least 100 ms in order to guarantee the registering a serial break event and subsequently generate a full reset.**

---

## 7 Modem 6 platform concepts and definitions

### 7.1 Unit ID (UID)

The UID is a unit id that is unique and cannot be reconfigured. It is represented as a 6-digit hexadecimal number, for example, 0x00411A.

### 7.2 Acoustic frequency band

There are two frequency bands of operation that are covered by the Modem 6 product range. A single modem is designed to operate in a single band and cannot be reconfigured to switch to a different band of operation.

The LMF band covers a frequency range from 14 kHz to 19 kHz.


The MF band covers a frequency range from 20 to 34 kHz. The operational modem frequency of the units is set to 26.5kHz +/- 4kHz.

### 7.3 Acoustic addresses

Every Sonardyne Wideband instrument has a configurable acoustic address. This address is required and used by many serial commands in order to request a transceiver to navigate or send acoustic commands to. The acoustic address, along with the frequency band of operation, determines the acoustic signaling used for navigation.

---

### Note

 **Acoustic address designators are reused between acoustic frequency bands but are still unique. Address 2010 in the MF band refers to a different set of acoustic signals than address 2010 in the LMF frequency band.**

---


Addresses are divided into families. Families are then grouped by the type of Wideband signaling used. The address is a 4-digit number where the first two digits denote the family and the last two digits represent the channel within that family.

**Table 7-1 Address families**

Family range	Signalling
01-15	Wideband 1 (legacy)
17-31	Wideband 2
50-63	Wideband 2+

Within each address family there are 14 different channels (01 through 14). This allows for over 200 unique acoustic addresses per group per acoustic frequency band.

**Note**

 **Acoustic addresses in the range 101 through 1514 are legacy addresses that use Wideband 1 signalling. Wideband 2 has increased detection performance over Wideband 1 and is preferred over Wideband 1 in all scenarios.**

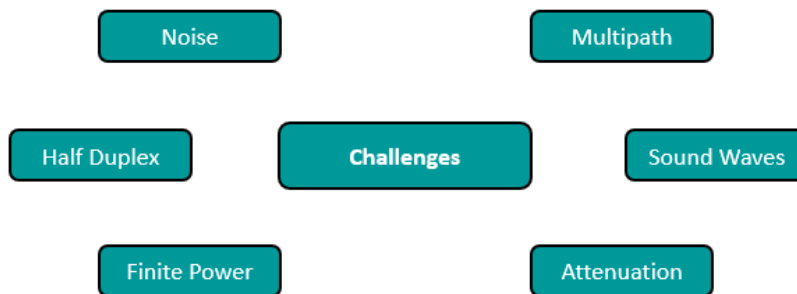
## 8 Modem 6 protocol

This section describes how a Modem 6 operates.

### 8.1 Acoustic modem challenges

An ideal modem link would behave as a wired connection. An acoustic link by its very nature interposes its own set of challenges.

**Figure 8-1 Acoustic modem link challenges**



The challenges shown in *Figure 8-1* often result in significant latency in the link. This is governed by the speed of sound in water and the signaling rate of the underlying telemetry scheme. The time-varying nature of the communication channel causes significant levels of Bit Error Rate (BER), in comparison to a wired link. More details on overcoming these issues can be found in *Section 10.1 "Installation considerations:"*.

### 8.2 MDFT

MDFT is Sonardyne’s overall acoustic protocol for transferring data, used in Modem 6 products. MDFT can refer to a single modem transaction that involves a pair of Modem 6 units. The transaction is always initiated from one modem, the master, and provides two-way data transfer to another modem, termed the slave.

During a MDFT transaction, the master sends a packet of data down to the slave, which extracts the data out of its serial port, waits for any response and sends back any pending data of its own. In benign conditions where the data is received correctly at both ends the transfer is deemed complete. In the event of missing data the master can initiate a series of retries to resend or re-request the missing data in a process termed packet stitching.

A Modem 6 unit has a number of configurable parameters that can adjust the timings and behaviour of the link under conditions where retries are required; see *section 9.3.2 "Transferring data (MDFT command)"* for a detailed explanation of each parameter.

## 9 Modem 6 configuration

This section describes the parameters that can be used to configure a Modem 6.

### 9.1 Reading fixed parameters

The fixed parameters can be read by using the Fixed Status (**FS**) command.

#### 9.1.1 Unit ID

The UID is a 24-bit number that is unique to each Sonardyne 6G instrument. The UID is reported, as a 6-digit hexadecimal value, as part of a FS reply and is denoted by the **U** parameter.

```
<FS
```

```
>FS:2709,U004849,FL001F,FV3.05.00.05,TDR;MF;OMNI;187;181;166
```

#### 9.1.2 Firmware version

The firmware version is reported as part of a FS reply and is denoted by the Fixed Status (**FS**) parameter. The firmware version is denoted by a build, revision, development and version. The values of which are separated by `.`.

```
<FS
```

```
>FS:2709,U004849,FL001F,FV3.05.00.05,TDR;MF;OMNI;187;181;166
```

#### 9.1.3 Transducer information

The acoustic frequency band and transducer type that a Modem 6 supports is reported after the Transducer (**TDR**) parameter in a FS command response. The acoustic band will be denoted by **MF** or **LMF**, the transducer type will be denoted by either **DIR** or **OMNI** (directional or omni-directional respectfully). In addition, a series of numerical values follow, which give the available acoustic power level settings that the Modem 6 supports.

```
<FS
```

```
>FS:2709,U004849,FL001F,FV3.05.00.05,TDR;MF;OMNI;187;181;166
```

---

#### Note



The available power levels vary depending on the specific Modem 6 product.

---

## 9.2 Basic acoustic configuration

The Modem 6 unit has configurable power and gain settings. In order to optimise an acoustic link, the power and gain settings at each end of the acoustic link need to be configured appropriately.

---

### 9.2.1 Setting the acoustic gain

There are seven different gain levels that are guaranteed to be supported in all Modem 6 products. These levels span a range between 0 dB and 40 dB (equivalent to x1 through to x100).

**Table 9-1 Supported gain values**

Supported gain values
0 dB
6 dB
14 dB
20 dB
26 dB
34 dB

To set the gain the desired value should be used in conjunction with the Linear Gain (**LG**) parameter within a CS command.

<CS:LG20

>CS:TAT200, BLK100, RXW4800, TXW100, NPL187, SPL181, TPL181, LG20, CIS0, AT8, EC1, ME0, RSP0, PPR0

### 9.2.2 Setting the power levels

There are several different power level settings available for Modem 6, the exact number and levels depend on the specific product. The control of power within any Modem 6 instrument is split across three different parameter settings, all reported within the CS command.

#### 9.2.2.1 Navigation Power Level (NPL)

The NPL is used to control the power level for all short navigation interrogations and replies. The desired NPL parameter should be used in conjunction with the NPL parameter in a CS command.

#### 9.2.2.2 Start Power Level (SPL)

The SPL is used to control the power level for the first two short acoustic pulses that begin a telemetry block of data. These initial pulses provide receiver synchronisation. The desired SPL parameter should be used in conjunction with the SPL parameter in a CS command.

**Note**

 **If the SPL value matches the TPL value then the SPL parameter is omitted from the serial CS response and the value of SPL will track the TPL value unless explicitly set differently.**

#### 9.2.2.3 Telemetry Power Level (TPL)

The TPL is used to control the power level for telemetry acoustics. The desired TPL parameter should be used in conjunction with the TPL parameter in a CS command.

**Note**

 **For a Modem 6 it is recommended that the NPL, SPL and TPL are configured to the same value.**


### 9.2.3 Setting the Receive Wait Time (RXW)

The RXW parameter is used to determine how long to wait for an acoustic reply for telemetry. It should be set based on the maximum slant range in the operating scenario, the maximum turn-around time (640 ms) and the sound speed.

**Table 9-2 Suggested RXW values**

Maximum slant range	Suggested RXW
< 250 m	1200 ms
< 500 m	1600 ms
< 1000 m	2400 ms
< 2000 m	3600 ms
< 3000 m	5200 ms
< 4000 m	6400 ms
< 5000 m	7600 ms
< 6000 m	9200 ms
< 7000 m	10400 ms
< 8000 m	12000 ms
< 9000 m	13200 ms
< 10000 m	14800 ms

#### Note

 If the RXW parameter is set much longer than is actually required, it will result in longer than necessary response times in the presence of failed acoustics which may hinder the update rate of the system.

## 9.3 Modem specific parameters

The Modem Status (MS) and MDFT commands contain all the parameters that are specific to modem applications. Many of the parameters are either not used or should be left at the default value for most modem applications.

### 9.3.1 Configuring the modem (MS command)

The MS command can be used to read and configure the modem status parameters of the instrument. Individual parameters can be set without affecting or knowing the other parameters. These parameters will remain set and are stored in memory, however they are not stored in non-volatile memory. Therefore, if the instrument is reset or its power cycled, the configuration will return to the last stored user defaults or factory defaults. The SC command STR;MS option can be used to store the user configured data to EEPROM as user defaults.

Table 9-3 MS command

<b>Command:</b>	<MS:DDx,MDx,UDx,TSx,Px,MRx,SMx,THRx,ICTx,MUx,FQx,MSTx,MUx,FFx,Bx <MS:aaaa,DDx,MDx,UDx,TSx,Px,MRx,SMx,THRx,ICTx,MUx,FQx,MSTx,FFx,Bx		
<b>Reply:</b>	>MS:aaaa,MVx,DDx,MDx,UDx,TSx,Px,MRx,SMx,ICTx,FQx,MSTx,MUx,FFx,Bx/x.x,Rx		
<b>Parameters</b>	<b>Valid input</b>	<b>Default value</b>	
MV#	Modem Version	Read Only	
DDx	Data Delay	32 ms* to 4096 ms	1024 ms
MDx	Modem Delay	32 ms to 16384 ms	512 ms
UDx	Uplink Delay	32 ms to 4096 ms	512 ms
TSx	Telemetry Scheme	0 to 7	1 : RPSK200
Px	Port	0 to 7	1 : Serial Data Port
MRx	Master Retries	0 to 7	1 (Advanced user)
SMx	Subframes Missed	0 to 7	1 (Advanced user)
THRx	THReshold	0 to 14 subframes	0
ICTx	Inter Character Time	32 ms to 32768 ms	32 ms
FQx	Forward Queue	0 or 1	0
MSTx	MaSTer mode	0 or 1	0
MUx	Multi User	0 or 1	0
FFx	Fire and Forget mode	0 or 1	0
Bx/x.x	Buffer Size and % used	4 KB to 512 KB	512 KB
R	Range	Microseconds	
DATA**	DATA	1 to 15	None

\* Many systems cap the minimum Data Delay value at 512 ms.

### Examples:

Locally setting the telemetry scheme and output port

```
<MS:TS3,P1
```

```
>MS:2011,MV1,DD128,MD512,UD512,TS3,P1,MR1,SM1,THR0,ICT32,FQ0,MST0,B512/0.0,R345322
```

Remotely setting the telemetry scheme and output port

```
<MS:2011:TS5,P0
```

```
>MS:2011,MV1,DD256,MD256,UD512,TS5,P0,MR1,SM1,THR0,ICT32,FQ0,MST0,B512/10.6,R345322
```

#### 9.3.1.1 MV: Modem Version

The modem protocol version (MV) is read only and specifies the valid parameters and acoustic behaviour of the instrument. The system must check that the modem version is compatible and supported by the master instrument on connection.

### 9.3.1.2 DD: Data Delay

The Data Delay (DD) parameter defines the time delay in the transmission between the end of one Sub Frame of telemetry and the start of the next. The Data Delay is specified in milliseconds and has the following quantisation:

**Table 9-4 Data Delay**

Data Delay (ms)
512
1024 (default)
2048
4096

The instrument will round upwards the input data delay value to the next permitted value in the list above, e.g. If DD500 was input, it would be rounded up to DD512. If a parameter value '#' is specified above the maximum or below the minimum an error message will be returned by the instrument (i.e. 'DD#?')

### 9.3.1.3 MD: Modem Delay

The Modem Delay (MD) parameter sets the maximum time delay between the end of transmission of the first Sub Frame (Command/Ack) and the start of transmission of the first Data Sub Frame in a Modem uplink Frame transfer sequence.

This delay allows the remote instrument to wait for the attached serial device to communicate data into its modem data buffer if it is currently empty. This time delay is activated once the Acknowledge Sub Frame has been transmitted in response to the End Sub Frame of the previous Downlink transmission. However, if data is already available in the remote instruments modem buffer then the minimum delay time for the transmission of the first Data Sub Frame in the uplink is referenced to the Acknowledge Sub Frame and is defined by the UD parameter setting.

The quantisation of the MD parameter value is shown below:

**Table 9-5 Modem Delay**

Modem Delay (ms)
32
64
128
256
512 (default)
1024
2048
4096
8192
16384

### 9.3.1.4 UD: Uplink Delay

The Uplink Delay (UD) parameter defines the time delay in the Uplink transmission between the end of one telemetry Sub Frame and the start of the next. The instrument will always wait for a minimum of either UD or MD before it responds. The quantisation of the UD parameter value is given below:

**Table 9-6 Uplink Delay**

Uplink Delay (ms)
32
64
128
256
512 (default)
1024
2048
4096

### 9.3.1.5 TS: Telemetry Scheme


The Telemetry Scheme (TS) parameter defines the telemetry scheme that the instrument will use for modem transfers. Modem links are often asymmetrical in telemetry scheme (one unit has a different TS setting than the other).

**Table 9-7 Telemetry Scheme**

TS parameter	Telemetry type	Supported modem
0	100 bps	All modems
1	200 bps (default)	All modems
2	400 bps	All modems
3	900 bps	All modems
4	HDR 3000 bps	Multi-element receivers only
5	HDR 6000 bps	Multi-element receivers only
6	RS 3500 bps	All modems
7	RS 9000 bps	All modems

The available telemetry schemes depend on firmware version and hardware platform capabilities. Attempts to select a telemetry scheme that is unavailable will be ignored by the instrument.

#### Note

 **The slower telemetry schemes (TS0 or TS1) are the most robust and are best suited to poor environmental conditions, it should be noted that the power consumption is not as efficient as the faster telemetry schemes. However the faster telemetry schemes may not be suitable in challenging environments.**

**Sonardyne recommends that users start at TS3 and increase the telemetry scheme until the correct balance between speed, power consumption and signal robustness is reached.**



### 9.3.1.6 P: Port

The Port (P) parameter defines the serial port on the unit that any received data will be sent to. The number of available serial ports is hardware dependent. If an invalid port is specified, the standard error message will be returned by the instrument and the P parameter setting will remain unchanged.

### 9.3.1.7 MR: Master Retries

The Master Retries (MR) parameter defines the number of times the master modem instrument will attempt to retrieve data that has been received in error. Only the data Sub Frames that were received in error are re-requested. Data Sub Frames will be pieced together automatically once they have all been received without errors. In a difficult acoustic environment this automatic re-request feature can be very powerful. However, it can result in latency in the data being delivered to the communications port.

Table 9-8 Master Retries

Master Retries
0 none
1 (default)
2- 7

### 9.3.1.8 SM: Sub-frames Missed

The Sub-frames Missed (SM) parameter sets the permitted number of consecutive Sub Frames that can be missed (i.e. not detected or decoded) before the receiving unit terminates the data reception. For the case where the transferred data is less than a single sub-frame in length this parameter has no effect.

Table 9-9 Missed Sub-frames

Missed Sub-frames
0 none
1 (default)
2- 7

A large number of missed Sub Frames can introduce a delay in the remote modem responding, and ultimately result in a reduction to the user data rate. The SM parameter can be used to control this delay.

### 9.3.1.9 THR: Threshold

The Threshold (THR) parameter contains the number of Sub Frames that make up a Modem Data Frame Transfer (MDFT). A value of 0 (default) denotes that the usual 16 Sub Frames are used, values 1 through 14 reduce the number accordingly.

### 9.3.1.10 ICT: Inter Character Time

The Inter Character Time (ICT) parameter controls the timeout (in milliseconds) after receiving a serial modem input until automatic modem transfer takes place. The MST, THR parameters must also be configured correctly for the modem to initiate a frame transfer.

#### **9.3.1.11 FQ: Forward Queue**

The Forward Queue (FQ) parameter controls whether the contents from the last modem Frame transfer will be automatically cleared even if the transfer is unsuccessful. When set to 1, the buffer is always cleared. When set to 0, the contents will remain if the modem Frame transfer was unsuccessful.

#### **9.3.1.12 MST: Master mode**

The Master (MST) mode parameter controls whether the instrument will operate in autonomous master mode. For automatic modem transfer to take place the MST parameter must be set to 1 and the ICT and THR parameters configured correctly. When set to 0 this mode is disabled and the ICT and THR parameters are unused.

#### **9.3.1.13 MU: Multi-user mode**

The Multi-user (MU) mode flag controls whether telemetry is sent using a carrier frequency that is the same as the instruments IIS or IRS (Address). If not in Multi-user mode an operating band central carrier frequency that provides the most efficient transfer of data is used. The default setting is for Multi-user mode to be disabled (MU0) to ensure maximum efficiency.

#### **9.3.1.14 FF: Fire and Forget mode**

The Fire and Forget (FF) mode flag controls whether, during a MDFT transfer, data is simply transmitted without then proceeding to listen for acknowledgements or reply data. A value of 1 enables Fire and Forget mode which is usually only used when low latency is desired and old data is not important (i.e. streaming 1Hz telegrams across an acoustic link).

#### **9.3.1.15 DATA: Load data test command**

The DATA command is used to load the Modem buffer with ASCII printable data. The amount of data that is loaded depends on the configured TS and the number following the DATA parameter. The number following the DATA parameter specifies how many sub-frames of data are to be loaded into the modem buffer and the sub-frame size depends on the telemetry scheme. The amount of data in the modem buffer is shown in the Buffer size \ percentage used. This command can be sent multiple times to increase the amount of data in the modem queue.

### 9.3.2 Transferring data (MDFT command)

The MDFT command initiates a modem data Frame transfer.

<b>Command:</b>	<MDFT:aaaa;W#,RS#,SPR#,AH,HDR <MDFT:aaaa cccccccccccccc... <MDFT (Local command to interrogate local Modem buffer state )	
<b>Reply:</b>	>MDFT:aaaa,LDAX,RDAX,DCx >MDFT:aaaa,NO_REPLY >MDFT:aaaa,LDA0,RDA0,DC23 cc...ccc (if command and data port are the same) >MDFT:[BUSY,]QUEUED;x	
<b>Parameters</b>	<b>Description</b>	<b>Values</b>
aaaa	Address of Remote Modem Compatt	
cccc...	The ' ' identifies the following characters, 'ccc..' to be free form text and is to be interpreted as modem data for transfer on the Downlink.	
LDAX	Local Modem Data Available in buffer for download	'x' = 1: TRUE 'x' = 0: FALSE
RDAX	Remote Modem Data Available in buffer for upload	'x' = 1: TRUE 'x' = 0: FALSE
RSx	Allows the resetting of the local or remote instrument. This clears the contents of the modem buffer prior to the modem frame transfer.	'x' = 1: Reset local modem 'x' = 2 Reset remote modem 'x' = 3 Reset both modems
SPRx	Allows suppression of either the downlink or the uplink portion of the modem frame transfer	'x' = 1: Suppress the downlink 'x' = 2: Suppress the uplink
AH	Flag that the data is ASCII HEX format	No parameters
DCx	Data Count, number of data byte received	
BUSY	Indicates that a Modem Frame transfer is currently in progress	
QUEUED;x	'x' indicates the number of characters in the local Modem buffer that will be sent on the next Modem frame transfer. Note that this value is displayed as zero whenever a Modem Frame transfer is in progress.	
HDR	Will append the Modem command header to the data before outputting to the user can see where the data came from	No parameters


Examples	Explanation
<pre>&lt;MDFT:2012 This is Modem data to send &gt;MDFT:2012,LDA0,RDA1,DC234</pre>	<p>Perform a transfer with unit address 2012</p> <p>Successfully completed transfer, FEC ok and there's more data available in the Remote modem's buffer. 234 data bytes have been received and sent out of the data port.</p>
<pre>&lt;MDFT &gt;MDFT:BUSY,QUEUED,0 or &gt;MDFT:QUEUED,242</pre>	<p>Query local Modem status.</p> <p>This reply indicates Modem Frame transfer is currently in progress.</p> <p>This reply indicates Modem is currently not active and there are 242 data bytes currently in the local Modem buffer to be sent on next Frame transfer.</p>
<pre>&lt;MDFT:RS1 &gt;MDFT:QUEUED,0</pre>	<p>Command to flush the contents of the local Modem buffer.</p> <p>Reply indicates Modem is currently not active and the local Modem buffer is empty.</p>

## 9.4 Storing the configuration

The Modem 6 unit has non-volatile storage which is used to keep a copy of the configuration. The configuration is loaded on a cold start. To transfer the current configuration to non-volatile storage it is necessary to send a STR command serially.

```
<STR
>STR:OK
```

### Note

 Some configuration parameters are automatically written to non-volatile storage whenever they are changed. These include all configurable parameters in the PORT and SC command.

## 10 Example step-by-step integration

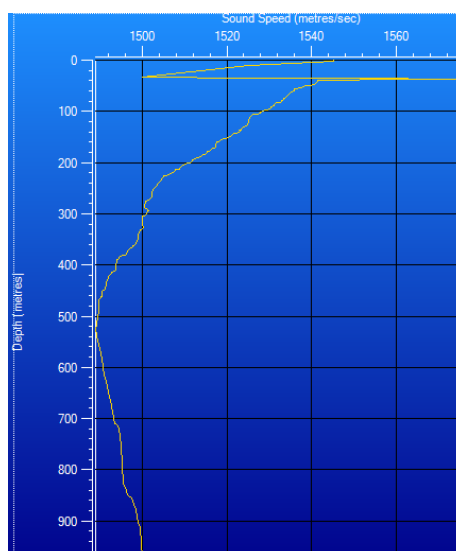
There are a multitude of possible combinations of operating scenarios that are feasible when using a Modem 6 instrument. The following section, taking lead from the above users' cases, takes a more in depth look at the integration of two applications. It may be the case that a particular integration only requires a subset of the functionality described below or that an integration will have to deviate substantially from that laid out below. In either case it is worth reading through the complete manual as it contains a number of hints for debugging an integration that whilst only mentioned once are applicable in multiple areas.

## 10.1 Installation considerations:

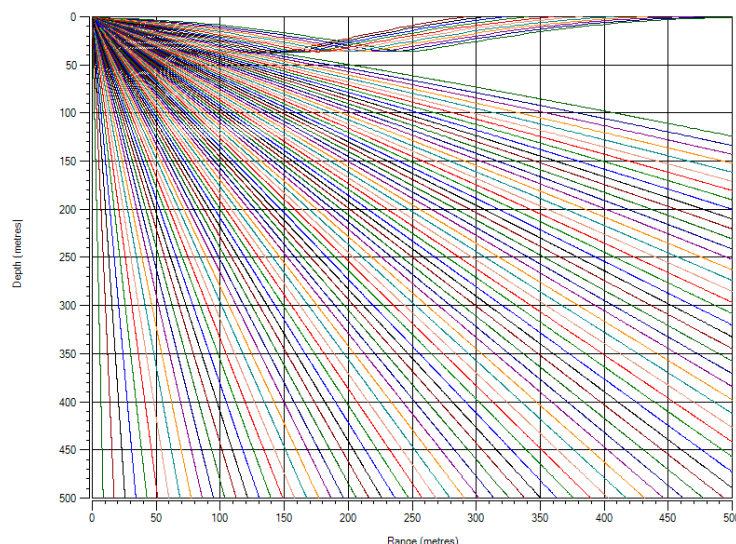
It is important to consider the following points when planning modem integration, more information on the issues raised in this section can be found in the "Transponder mounting and acoustic communications" Application Note:

- Acoustic modems require line of sight
  - In order for an acoustic signal to reach its destination there must be a clear path between the modems. Therefore, it is important to plan installations so that there is no infrastructure blocking the acoustic path.
- Acoustic signals do not travel in straight lines
  - Acoustic signals are said to be 'lazy'. What is meant by this is that the acoustic signal will always float towards a slower sound velocity in the water column. In the sound profile example below, there is an abrupt change in the sound velocity at around 40 m. By processing this profile with acoustic ray tracing software it is possible to see the predicted acoustic paths from an omni-directional transducer. It is also possible to see that there are two shadow zones where the acoustic signals do not reach.

**Figure 10-1 Sound Velocity Profile**

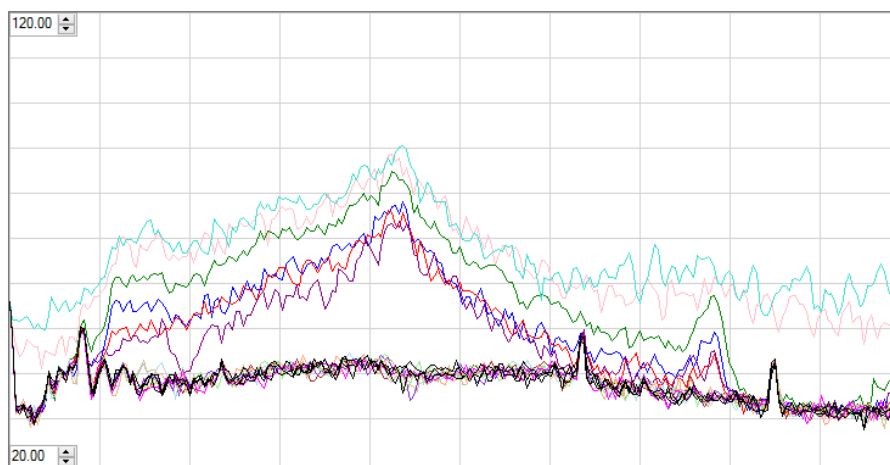


**Figure 10-2 Ray path analysis**



- Noise produced from vessel and infrastructure cause interference
  - When working with acoustics, one person's signal is another person's noise. It is always important to look at other systems operating in the local area of a modem. If the modem is vessel mounted then systems such as USBL or echo sounders which operating within 19–32 kHz are a source of noise which the modem must overcome. In some cases it will be easy to switch off the noise source, in other cases such as the Fast Fourier Transform (FFT) capture below it is not as easy to disable a vessels thrusters, that said if a vessel is placed on Dynamic Positioning (DP) then there can be options to relax the positioning accuracy and reduce the frequency that the thrusters power up:

**Figure 10-3 FFT Spontaneous noise floor increases**



Air is an acoustic isolator

- The positioning of modems is also affected by sources of white water and air. If a modem is close to a thruster then the air bubbles within the white water will produce a significant attenuation effect. In this case it is preferable to move the modem to another location or to lower the modem away from the white water.
- The longer the transmission distance the more signal attenuation is observed.
- The further through the water column which sound must travel the more losses are observed by the signal. These losses come from the attenuation of the signal by the water and through signal spreading. It is important to configure the units which are being deployed so that they have sufficient energy to arrive at their destination with sufficient signal level so as to be received and decided cleanly.

## 10.2 Normal boot sequence

The normal start sequence of a Modem 6 instrument after power is applied, is to execute the bootloader before continuing to load the firmware and then passing control to the application firmware once loaded into its memory. The firmware will start running automatically using the last stored user configuration; if a user configuration is not available the firmware will revert to use a saved "Factory" configuration.

### 10.3 Initial configuration

As a minimum, the receiver gain, power levels and receive wait time should be configured. This can be done once and saved to non-volatile memory. The choice of acoustic settings should be derived from the maximum operating slant range required during the duration of the mission using the following table as guidance:

**Table 10-1 Recommended configuration at varying slant ranges**

Range (m)	Omni - Directional			Directional			Modem transceiver			ALL
	NPL	TPL	LG	NPL	TPL	LG	NPL	TPL	LG	RXW
25	166	166	14	169	169	14	169	169	34	800
100	187	187	0	190	190	0	187	187	20	800
500	187	187	6	190	190	6	190	187	26	1600
1000	187	187	20	190	190	20	190	187	40	2000
2000	190	190	26	196	196	26	196	190	46	3600
4000	196	190	34	199	196	34	199	190	54	6400
6000	196	190	40	199	196	40	199	190	60	8800

### 10.4 Enabling diagnostics

It is recommended to turn on a basic level of diagnostics to help observe and analyse the robustness and reliability of received acoustics to the modem. To enable basic diagnostics a DIAG command should be sent.

```
<DIAG:XC,TEL,FEC
```

```
>DIAG:2010,FEC,TEL,DBV,SNR,XC,P0,DEV0,SYS0,MOD0,RX0,TX0,ERR0
```

Once diagnostics are enabled, any serial command that utilises the acoustic receivers in the modem will append diagnostic data to the usual command response. This diagnostic data is encapsulated in square brackets.

```
<MR:2709
```

```
>MR:2709;R420023[XC97,SNR36,DBV-22,TEL;NONE]
```

#### Note

 **Diagnostic settings, as set by a DIAG command are not saved to non-volatile memory. On a cold start, diagnostics are deliberately turned off hence a DIAG command should be sent after power up or after a forced external reset.**

To turn off diagnostics, the NONE parameter should be used in conjunction with the DIAG command.

```
<DIAG:NONE
```

```
>DIAG:2010,NONE,P0,DEV0,SYS0,MOD0,RX0,TX0,ERR0
```

### 10.4.1 Hardware self-test

Prior to the start of any vehicle operation, it is advised to run the hardware self-test on the modem. The self-test will attempt to electronically validate as many subsystems of the unit as possible and report any problems to the user. To perform a self-test, a CKHW command can be sent which will report a **PASS** as part of the serial response if all subsystems are working correctly.

<CKHW

>CKHW:PASS

If the command returns FAIL, please contact Sonardyne's Product helpline:

[support@sonardyne.com](mailto:support@sonardyne.com). Alternatively, Sonardyne's 24HR Emergency Telephone Helpline can be called:

+44 (0) 1252 877600. During normal office hours, this is answered between 08:00 and 17:00 GMT. Outside of these hours, your call is automatically transferred to our out of hours agency who will log the details of your emergency and alert the appropriate Sonardyne personnel.

### 10.4.2 Battery checks

The Modem 6 instruments with the exception of the Modem Transceiver all have intelligently monitored battery packs, for the Modem 6 standard, these are large non-rechargeable batteries. All other units contain re-chargeable batteries. The Volatile Status (VS) command reports the capacity of the battery in addition to its current capacity remaining and voltage level.

**Table 10-2 Volatile status command**

<b>Command:</b>	<VS:aaaa	Request Volatile Status Information
<b>Reply:</b>	>VS:aaaa,WKT <sub>x</sub> ,HPR <sub>xx</sub> ,EXT,TILT,OV,CAS,BT <sub>x</sub> ;type;VLT <sub>x.x</sub> ;IDC <sub>x.x</sub> ;CAP <sub>x.x/x.x</sub> ;Tx <sub>x</sub> ;DIS;CHG,R <sub>x</sub>	
<b>Parameters</b>	<b>Description</b>	
	aaaa	Address
	WKT	Wake Up Tone
	HPR	HiPAP Channel
*Flag	EXT	External power connected (and being used)
*Flag	TILT	The unit is tilted at greater than 45deg from the vertical.
*Flag	OV	Override flag – Battery Low or Tilted
*Flag	CAS	Casius – Sonardyne calibration mode
Battery	BT <sub>x</sub>	Battery number, can have multiple batteries
	type	LI_ION, LI, ALK
	VLT	Battery or External Voltage
	IDC	Current Drain/Charge in mA, (positive value battery is charging, negative value battery is delivering current).
	CAP	Battery Capacity Total (Ahr) and Remaining (%)
	T	Battery Temperature
*Flag	DIS	Battery DISconnected flag – if Disconnect capability supported
*Flag	CHG	Battery Charger enabled – if rechargeable battery fitted

\* Omitted if not set or supported



Example command and reply:-

```
<VS:2011      (Request remote modem Address 2011 volatile status)
>VS:2011,WKT1,HPR45,EXT,TILT,BT1;LI_I0N;VLT14.9;IDC-12.6;CAP2.4/93;T20.4;CHG,R345422
```

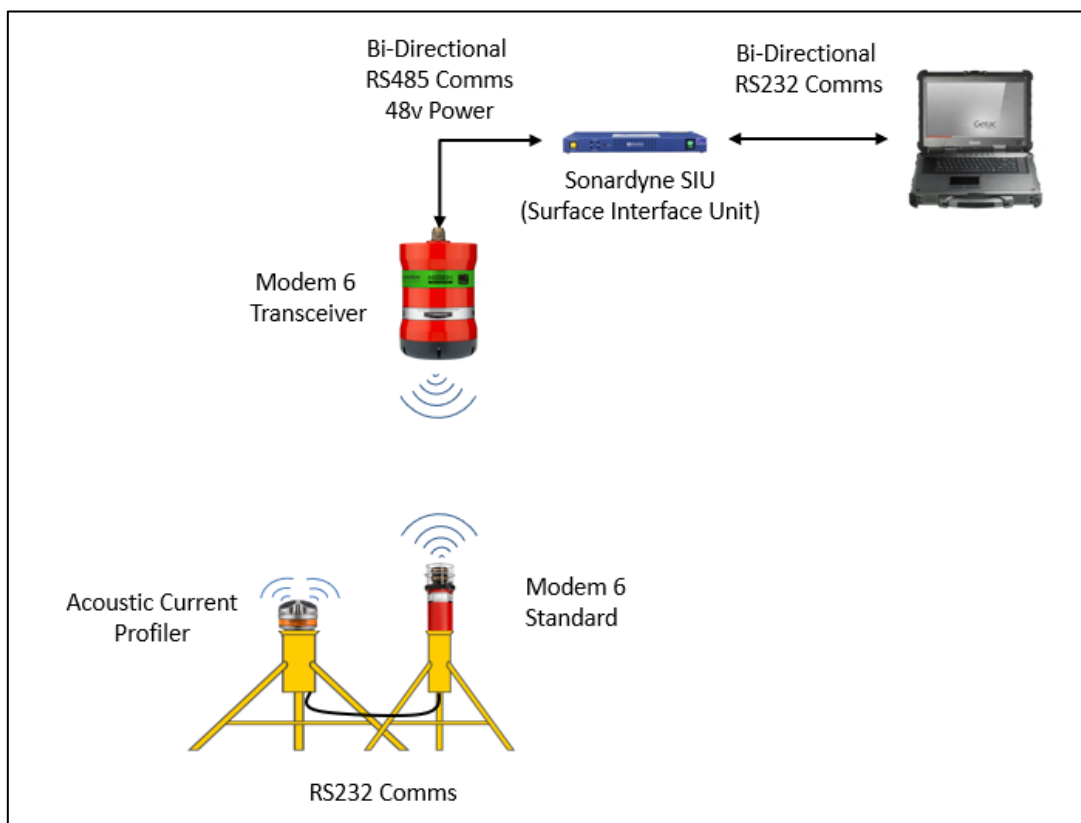
## 11 In depth integration examples

The following section looks at two specific applications and explains in depth the complete process of connecting the modem to the instrument and then recovering the data.

### 11.1 Integration example 1 – Acoustic current profiler

In this application a Modem 6 has been integrated into an acoustic current profiler in 2000 m of water. The profiler takes a reading every 30 minutes and passes the raw binary data into the modem’s buffer. On the surface, a Modem 6 Transceiver is deployed on a vessel and is connected to a Sonardyne Surface Interface Unit (SIU). The SIU provides 48 V power and interfaces with RS485 half-duplex comms. The SIU is powered by the vessel’s mains voltage supply via an International Electrical Connector (IEC) and to a computer with a RS232 serial cable. As shown in *Figure 11-1*.

**Figure 11-1 Integration example 1 system diagram**



#### 11.1.1 Modem integration

The following table (*Table 11-1*) documents the interconnections made between the Modem 6 and the standalone acoustic current profiler. As can be seen in the table, only an RS232 connection is made between the two devices. It is possible for the Modem 6 to power the profiler but in this instance the profiler is a self-powered autonomous device.

Table 11-1 Integration example 1 pinout

Modem 6			Acoustic current profiler	
Pin	Details	Description	Description	Pin
1	RS232 In	Host Port 0	N/C	N/C
2	GND	Power and Comms GND	Comms GND	5
3	RS232 Out	Host Port 0	N/C	N/C
4	Power In	8v-18v, Quiescent Power only (Not Acoustic Transmission)	N/C	N/C
		18v-24v, Quiescent and Ping Power (Not Telemetry)	N/C	N/C
5	Power Out	12v Regulated or v Batt	N/C	N/C
6	Sync	Responder Input	N/C	N/C
7	RS232 Out	Host Port 1	RS232 RX	1
8	RS232 In	Host Port 1	RS232 TX	3

### 11.1.2 Surface modem configuration

As the data being sent via the modem is in a binary format the primary comm port (P0) of the Modem 6 Transceiver is used for command and control and the secondary comm port (P1) is used as a data port. This allows for binary data to be streamed out of P1 without needing additional 3rd party user-sourced software to determine whether the data is a command response or binary modem data.

Firstly, the ports are configured, in this instance both P0 & P1 will be configured for RS485 Half-Duplex comms. The Sonardyne SIU has been configured to 38400 baud rate, with P0 as CF0 (Command Port) and P1 as CF1 (Data Port):

```
PORT:P0;BR38400;CF0;RS485,P1;BR38400;CF1;RS485
```

The next step is to configure the MS settings of the transceiver, these settings will decide how the data being transferred is handled, the majority of the settings which are required will be on the subsea modem, the only change needed is to command the transceiver to output the data on P1:

```
MS:P1
```

Ensure that the acoustic source and receive levels are set appropriately for the operating environment. As the system is operating in 2000 meters of water the depth operating guidelines can be referenced, found in *Section 10.3 "Initial configuration"*. In 2000m depth with a Modem 6 transceiver, it is recommended to use a Navigation Power Level (**NPL**) of 196, Telemetry Power Level (**TPL**) of 190, Linear Gain (**LG**) of 46 and a Receive Wait Time (**RXW**) of 3600 ms:

```
CS:NPL196,TPL190,LG46,RXW3600
```

### 11.1.3 Subsea modem configuration

With the surface modem system fully configured the subsea modem can now be configured. This can be done either serially or acoustically and both methods will be listed below. In this example, the subsea modem's acoustic address is 2401.

Firstly, the PORT settings are configured to match the wiring of the interconnection cable and the baud rate of the current profiler which in this example is set to 57600 the below example shows a local command followed by an acoustic command to a remote modem:

```
PORT:P1;CF1;BR57600
PORT:2401;W1,P1;CF1;BR57600
```

With the ports configured the unit can be configured for how the user wants the modem to respond to the data which it receives. In this example the current profiler will be autonomously waking up, taking a reading and passing that data to the modem every 30 minutes. Initially the unit will be configured to store the data until requested from the surface modem, then, in the subsequent example the modem will automatically send the data to the surface.

For the initial setup the unit will be set into Acknowledge mode FF0. Master (**MST**) configuration will be disabled to prevent the modem from automatically sending the data to the Modem 6 Transceiver. The settings of the modem data port also need to be P1, to match the above port settings. The Telemetry Scheme (**TS**) of the unit will be set to operate at 9000 bps (TS7).

```
MS:FF0,MST0,P1,TS7
MS:2401,MST0,P1,TS7
```

With all the MS settings applied, the acoustic settings of the subsea unit need to be set; these will differ to the surface Modem 6 Transceiver settings due to the different product variants. In this example the subsea Modem 6 has a directional transducer, the following settings for 2000 m found in *Section 10.3 "Initial configuration"* will be used; **NPL196**, **TPL196**, **LG26** and **RXW3600**:

```
CS:NPL196,TPL196,LG26,RXW3600,AT0
CS:2401;W1,NPL196,TPL196,LG26,RXW3600,AT0
```

#### 11.1.4 System operation

The system is now ready to begin modem operations. The subsea modem is reliant on the current profiler sending data into its buffer, this will be the control factor. Using the command below, the status of the modem buffer can be checked:

```
MS:2401;W1
MS:2401,MV1,DD1024,MD4096,UD512,TS7,P1,MR1,SM1,THR0,ICT256,FQ0,MST0,MU0,FF0,B512/0.0,R1660000
```

As shown in the response above, the buffer has reported 0.0, this indicates there is no data waiting to be sent on the subsea modem. When there is data available the command line response will show B512/1.36 representing the % of the buffer which is currently filled:

```
MS:2401,MV1,DD1024,MD4096,UD512,TS7,P1,MR1,SM1,THR0,ICT256,FQ0,MST0,MU0,FF0,B512/1.36,R1660000
```

The modem's total buffer size is currently set to 512 KB and now is 1.36% full, or 7 KB out of 512 KB.

Prior to beginning the upload, the user can select to enable diagnostics on the Modem 6 Transceiver to display the success of the modem transfer by showing the retries and the collected DC in the MDFT reply. To enable Receive (**RX**) and Modem (**MOD**) diagnostics send the following command:

```
DIAG:MOD1,RX1,P0
```

To begin the upload, the surface modem must perform a MDFT request which will then enable the subsea modem to upload its data. To do this the surface modem would send:

```
MDFT:2401;W1|X
```

The subsea unit will then begin to stream its data to the surface, with the diagnostics enabled the user will begin to see the following:

```
>[MOD:TX;15;MST1]
>[MOD:RX;15, FROM;2401,MY_ACKS;8000]
>[MOD:STATUS;16, ID;0]
>[MOD:THEIR_ACKS;8000]
>[MOD:DONE]
```

Upon completion of the transfer, the MDFT command shown below will be received showing the total Data Count (**DC**) which was uploaded via the transfer.

```
MDFT:2401,LDA0,RDA0,DC1729
```

With the system now configured, the user has the choice to either leave the system as it is and request the data when required or to configure the system to automatically send any data up to the surface when received from the sensor.

To set the unit to automatically send the data acoustically to the surface, the Master (**MST**) flag must be set to 1 on the subsea beacon.

```
MS:2401;W1,MST1
```

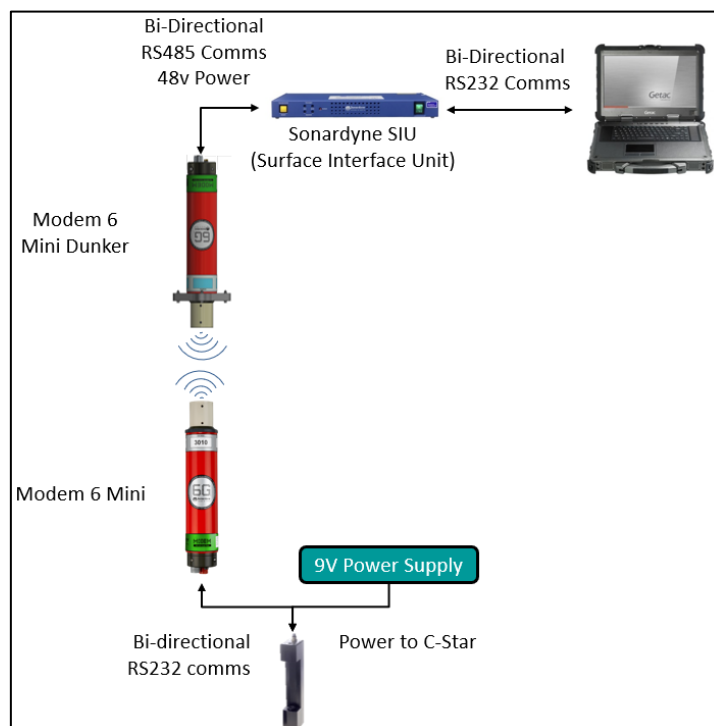
Upon completion of operations the user can stop the unit from automatically forwarding the data by setting the Master (**MST**) flag back to 0:

```
MS:2401;W1,MST0
```

## 11.2 Integration example 2 – Water quality sensor (Transmissometer)

In this application a Modem 6 Mini is connected to a C-Star Transmissometer FAS-000225 in 20 m of water. The C-Star will provide water quality measurements over a 30 minute period. The data that is required to be transferred to the surface is in a simple ASCII string format, which is fed into the subsea modem at a rate of 0.2 Hz.

Figure 11-2 Integration example 2 system diagram



### 11.2.1 Modem integration

Table 11-2 lists the pinout for the Y split cable that is providing power to the C-Star Transmissometer as well as two-way comms to the Modem 6 Mini. It is recommended that the user creates a similar table when integrating their own sensors with a Modem 6.

**Table 11-2 Integration example 2 pinout**

C-Star		Modem 6 Mini		Power supply	
Pin	Function	Pin	Function	Pin	Function
1	Ground (Comms + PWR)	4	RS232 GND	1	0V DC
2	RS232 RX	5	RS232 TX		
3	Reserved				
4	Voltage In			2	9V DC Out
5	RS232 TX	6	RS232 RX		
6	Reserved				

The C-Star is a preconfigured device which will output data at the required rate in an ASCII Hex format, for this operation the unit has been configured to take a reading every 5 seconds, which will be passed to the surface modem as a Fire and Forget (FF1) data transfer.

### 11.2.2 Surface modem configuration

The Modem 6 Mini Dunker is connected to a laptop via the SIU, with the cables provided. The Modem Mini Dunker is suspended approximately 2 m below the water line.

In this application it was decided to use a single serial port because the data being recovered is in a ASCII format and so can be logged straight on the command port of the surface modem.

For the MS settings of the surface modem, the data port was set to P0 and all other settings were left as default:

`MS:P0`

The unit is only being deployed in 20 m of water so the acoustic settings should be set to: Navigation Power Level (**NPL**) of 166, Telemetry Power Level (**TPL**) of 166 and Linear Gain (**LG**) of 14 as per the guidance table in *Section 10.3 "Initial configuration"*.

`CS:NPL166,TPL166,LG14`

### 11.2.3 Subsea modem configuration

The first part to set is the Port configuration; as the C-Star is plugged into P0 the Port settings must be set to match its baud rate on RS232. The command port must be set to CF0 to allow for both command and ASCII data:

`PORT:P0;BR9600;RS232;CF0`

`PORT:2401;W1,P0;BR9600;RS232;CF0`

The next step is to configure the MS settings of the subsea beacon. For this configuration the Modem 6 will be set to Fire and Forget (**FF1**) with the Forward Que enabled (**FQ1**) so that once the data is transmitted it is erased from the buffer, The system will also be set as Master (**MST1**) to automatically transmit data in its buffer. In addition to these settings the Inter Character Timeout (**ICT**) will be set to 100ms, this function tells the modem how long to wait after the last piece of data was received on its comm port before it should action the modem transfer. The unit will also be configured to operate at 9000bps which is Telemetry Scheme 7 (**TS7**):

```
MS:FF1,FQ1,MST1,ICT100,TS7
```

```
MS:2401;W1,FF1,FQ1,MST1,ICT100,TS7
```

Once again the last configuration to setup is the acoustic signal level and linear gains from the table (*Section 10.3 "Initial configuration"*):

```
CS:NPL166,TPL166,LG14
```

```
CS:2401;W1,NPL166,TPL166,LG14
```

### 11.3 System operation

With the system configured the modem can be deployed into the water. As the unit is lowered the C-Star will have already been streaming data into the modems buffer, the user has the choice as to whether to upload this initial data from pre deployment or to clear the buffer and only receive data sent after this point. If the user would like to receive all of the logged data then they can simply send the acoustic command:

```
MDFT:2401;W1|X
```

If the user only wants new data post deployment, **RS3** must be used, which resets both modems buffers prior to uploading any new data.

```
MDFT:2401;W1,RS3|X
```

Once the subsea modem has received the interrogation from the surface modem, it will begin streaming the data which is received into its buffer to the surface, which will in turn appear out of Comm port 1.

When the user wishes to stop the subsea modem from streaming data to the surface, they must send down the acoustic command shown below. The command must be sent in between the acoustics which are being sent to the surface or recover the system and remove the data input. This is why it is not recommended to use the Fire and Forget Mode when the subsea sensor is outputting data at a high rate.

```
MS:2401;W1,FF0,MST0
```

**Global Headquarters, UK**

T +44 1252 872288  
[sales@sonardyne.com](mailto:sales@sonardyne.com)

**Aberdeen, UK**

T +44 1224 707875  
[sales@sonardyne.com](mailto:sales@sonardyne.com)

**Houston, USA**

T +1 281 890 2120  
[usa.sales@sonardyne.com](mailto:usa.sales@sonardyne.com)

**Rio das Ostras, Brasil**

T +55 22 2123 4950  
[brasil.sales@sonardyne.com](mailto:brasil.sales@sonardyne.com)

**Singapore, Asia**

T +65 6542 1911  
[asia.sales@sonardyne.com](mailto:asia.sales@sonardyne.com)

**24/7 Emergency Helpline**

T +44 01252 877600  
[support@sonardyne.com](mailto:support@sonardyne.com)

[sonardyne.com](http://sonardyne.com)

